

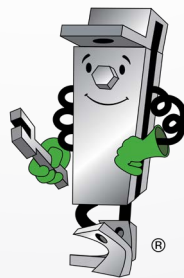

Nuclear Power Engineering NE-3

Engineering Data,
Channel & Combinations, Accessories



Atkore[™]
Unistrut



NUCLEAR POWER INDUSTRY PROCUREMENT PROGRAM

Unistrut Corporation has been serving the needs of the Nuclear Power Industry for over 40 years. Unistrut Metal Framing products provide structural support for millions of feet of conduit, pipe, and other applications in nearly all power plants throughout the United States.

Unistrut offers the largest array of metal framing products to the industry for safety related and commercial grade quality levels. Unistrut metal framing safety related products are certified to meet the requirements of 10 CFR 50, Appendix B. Unistrut also assumes responsibility for 10 CFR, part 21 as a part of its safety procurement program.

Unistrut Corporation offers the nuclear power industry a unique capability in its engineering quality and design programs. This means cost effective sourcing of metal framing products from the leader in the industry.

AISI COLD-FORMED STEEL DESIGN MANUAL, CHANGES IN ALLOWABLE LOAD CALCULATIONS

The beam and column loads given in this catalog are based on the 1996 edition of the AISI Cold-Formed Steel Design Manual.

Since the issuance of the first Nuclear Power Engineering Catalog (NE-1), the AISI Engineering Committee had continued to alter and modify the formulae for calculating allowable loads. Therefore, loads in the catalog may be different from those in the NE-1.

Unistrut's products for the nuclear industry have not decreased in strength. The materials and processes used to manufacture Unistrut nuclear products remain the same as they were for NE-1. However, the AISI formulae for allowable loads has changed.

As a leader in the nuclear industry for strut products, we believe that adhering to the latest engineering design standards for cold-formed steel is imperative. This catalog represents those latest design standards.

ASTM A 1011 STANDARD VS. ASTM A 570 STANDARD

In 2000, ASTM discontinued specification ASTM A 570 and replaced it with ASTM A 1011. Unistrut completed an engineering review of the two specifications and concluded that the chemical and mechanical properties of A 1011 SS Grade 33 are the same as A 570 Grade 33. Unistrut reserves the right to certify parts made from ASTM A 570 Grade 33 to ASTM A 1011 SS Grade 33.

Introduction	2
Pictorial Index	4 – 7
General Specifications	8
Channel & Combinations	9– 14
Channel Hole Patterns	15
Engineering Data	
Lateral Bracing Charts	15
Safe Bearing Loads	16
Design Load Data	17
Channel Nuts & Hardware	18 – 19
General Fittings	
Flat Plate Fittings	20 – 22
Ninety Degree Fittings	22 – 23
Angular Fittings	23
“Z” Shape Fittings	23 – 24
“U” Shape Fittings	24 – 26
Wing Shape Fittings	26
Post Bases	27
Special Fittings & End Caps	27
Brackets	27 – 28
Pipe Clamps	29 – 31
Beam Clamps	32 – 33
Concrete Inserts	34 – 35
Reference Tables & Data	
Formulae on Common Beam Loadings	36
Conversion Factors for Beams	37
Design Fundamentals	38
Axial Column Loads	39
Material Specifications & Index	40 – 42



N1000 Series (12 gauge)

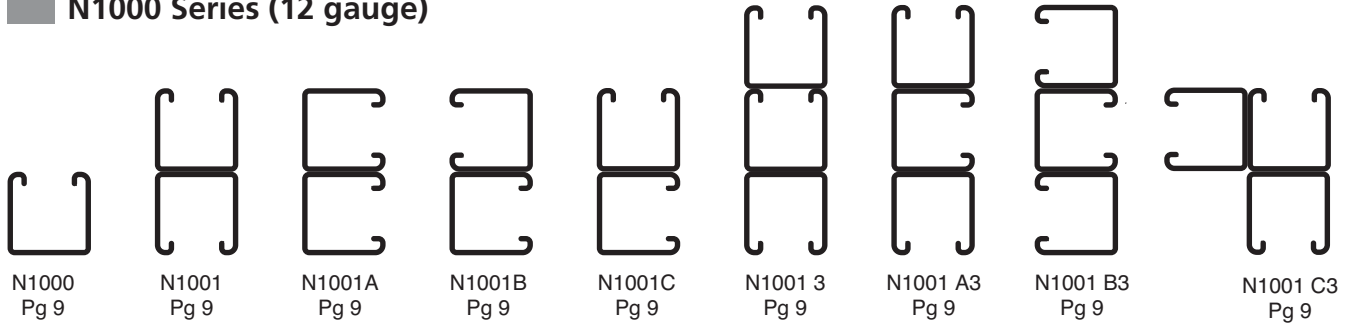

N3000 Series (12 gauge)

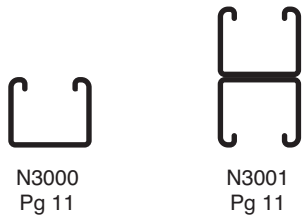

N3300 Series (12 gauge)

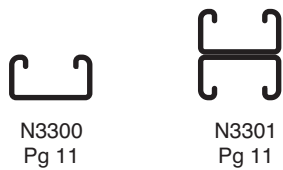

N5000 Series (12 gauge)

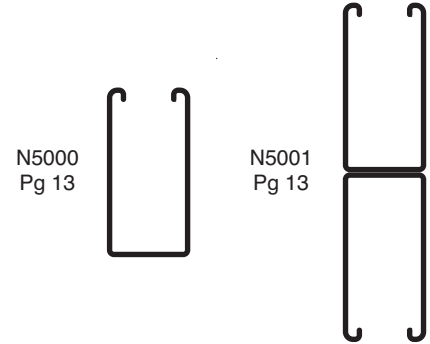

N5500 Series (12 gauge)

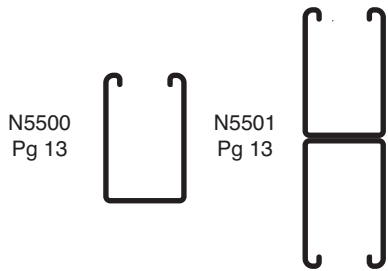

Standard Concrete Insert

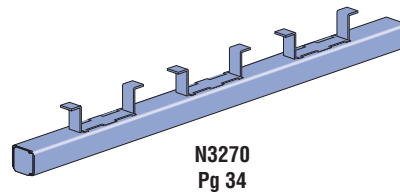

Light Concrete Insert

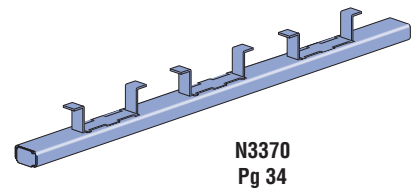

Pierced Channel

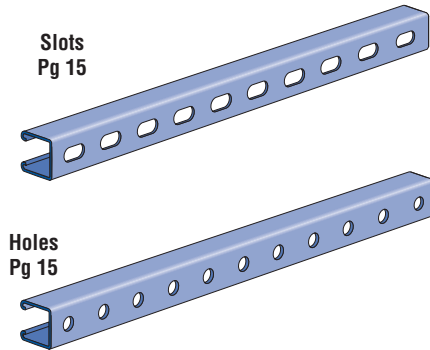

Concrete Insert Components

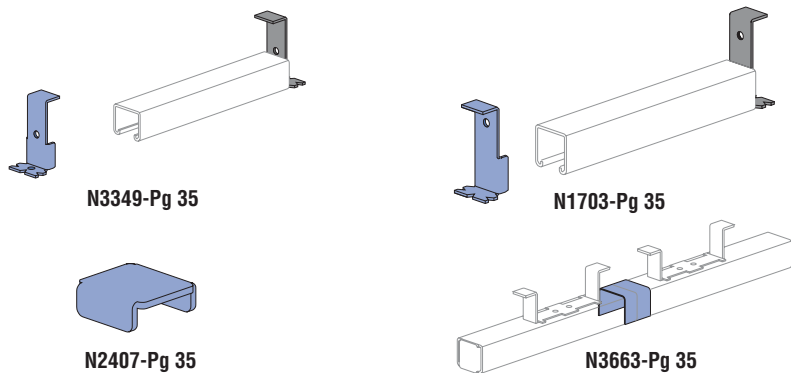

PICTORIAL INDEX

Channel Nuts With Spring

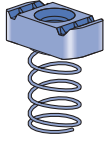

N1006 - N1010
Pg 18

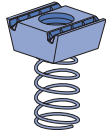

N1012S - N1023S
Pg 18



N4006S - N4010S
Pg 18

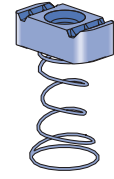

N5506 - N5510
Pg 18

Channel Nuts Without Spring

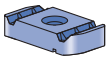

N3006 - N3010
Pg 18

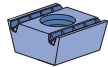

N1012 - N1023
Pg 18

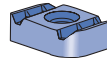

N4012 - N4023
Pg 18

Hardware

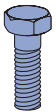

NHCS
Pg 19

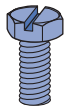

NSHS
Pg 19

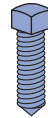

NCSS
Pg 19



NFLW
Pg 19



NHXN
Pg 19



NLKW
Pg 19

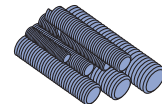

HTHR
Pg 19

Pipe & Conduit Clamps

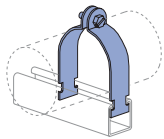

N1109 NH - Pg 29

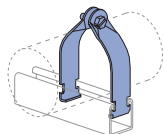

N1211 NH - Pg 29

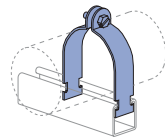

N1425 NH - Pg 30

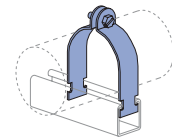

N2024 NH - 30

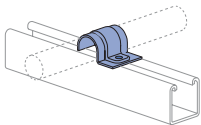

N2008 - Pg 31

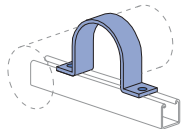

N2558 - 31



Flat Plate Fittings

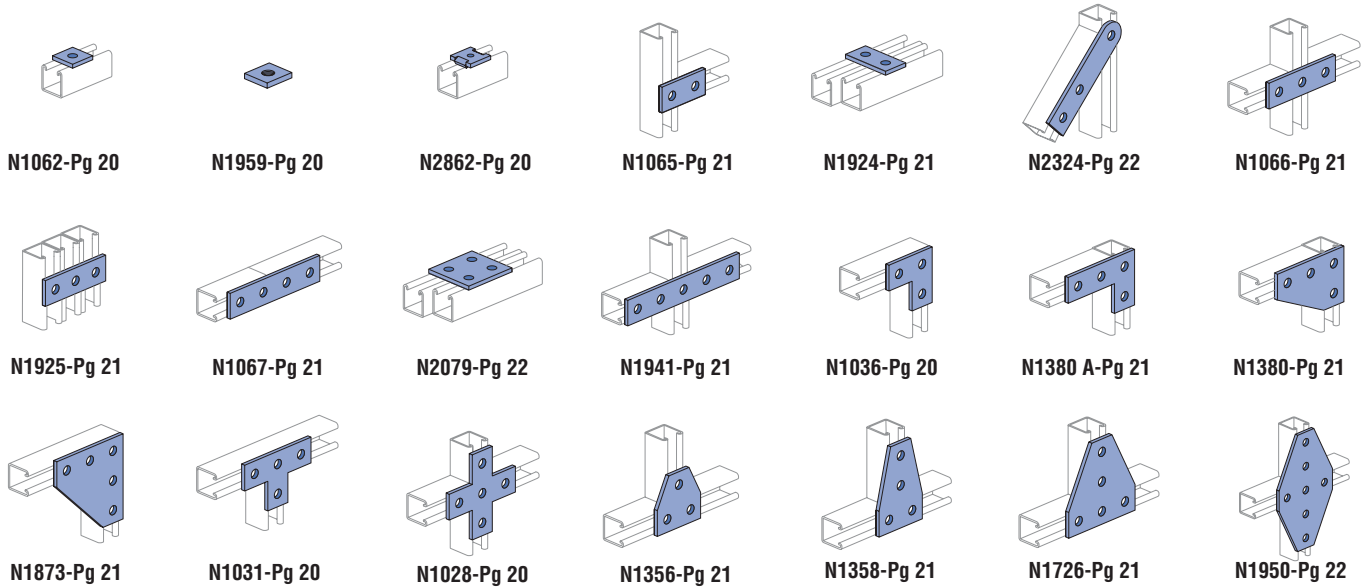

Angle Fittings

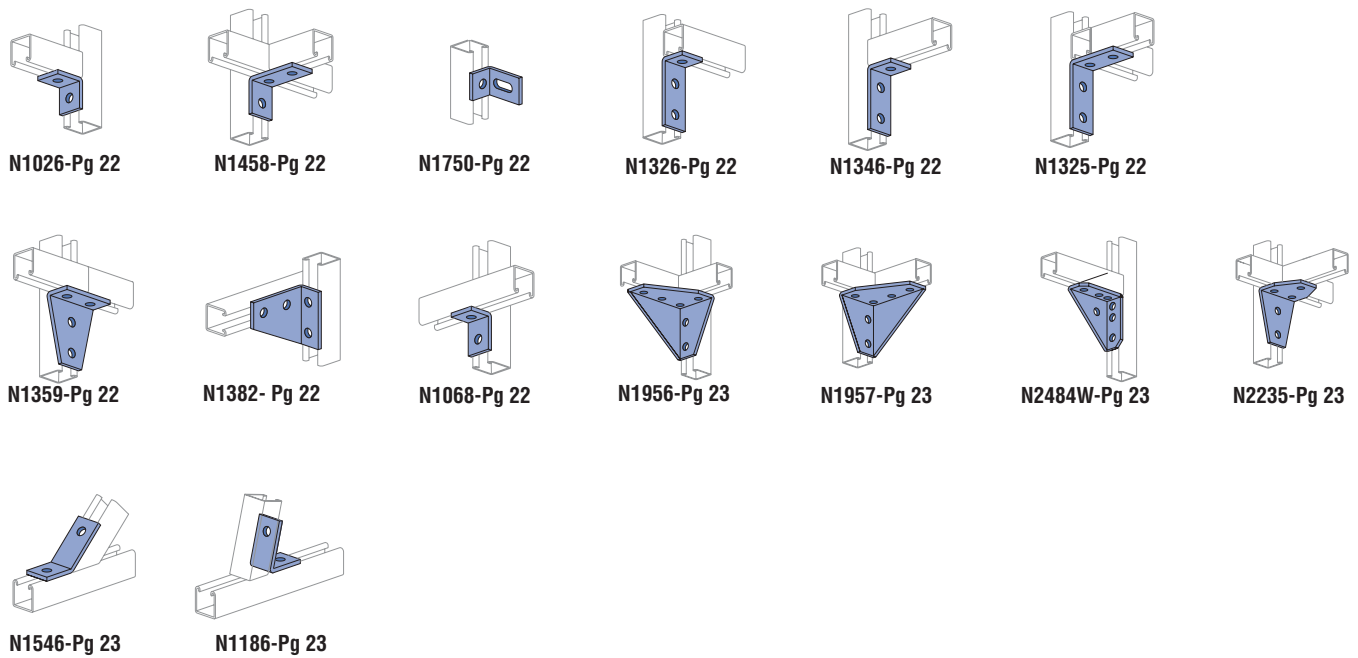

"Z" Shape Fittings

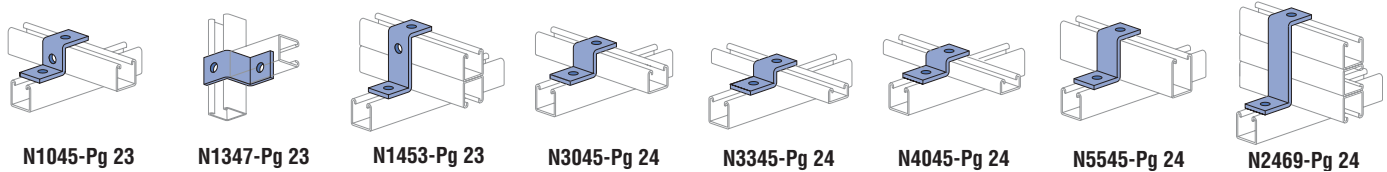

"U" Shape Fittings

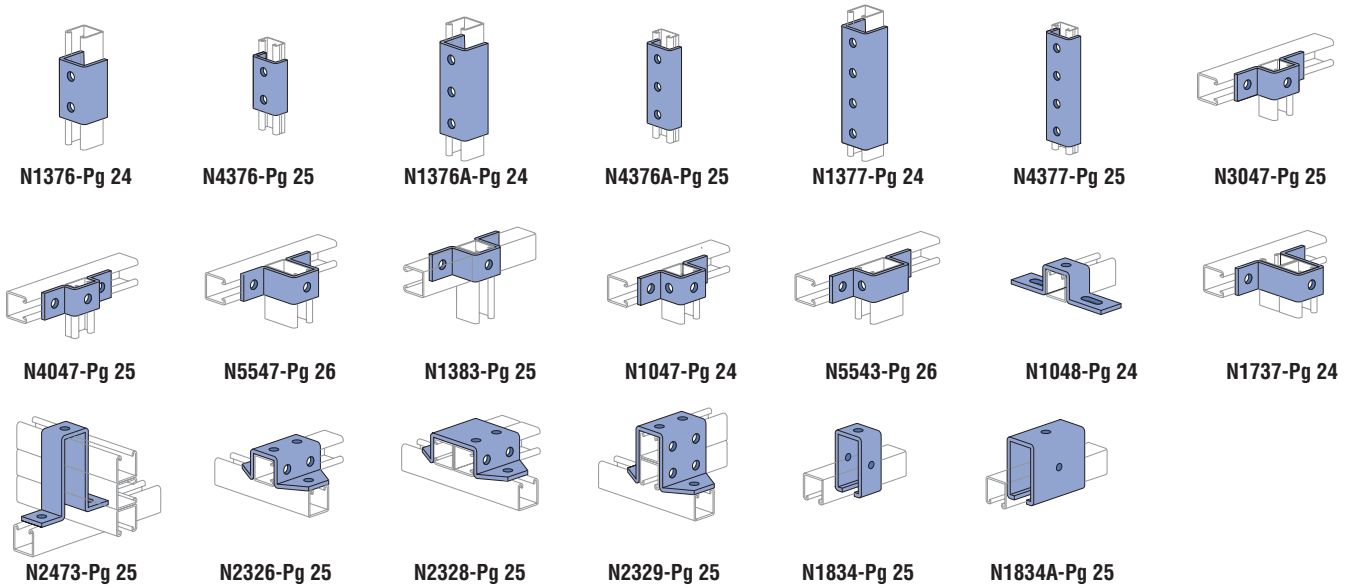

Wing Shape Fittings

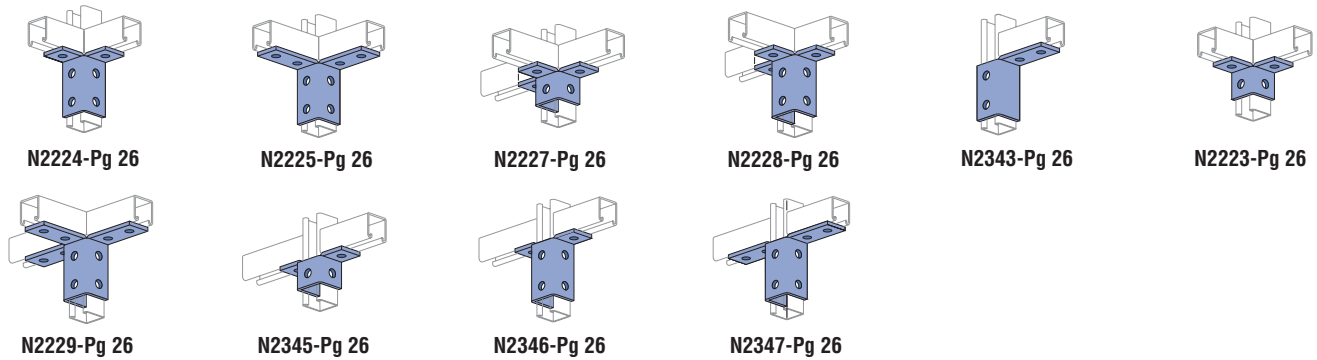

Post Bases and Brackets

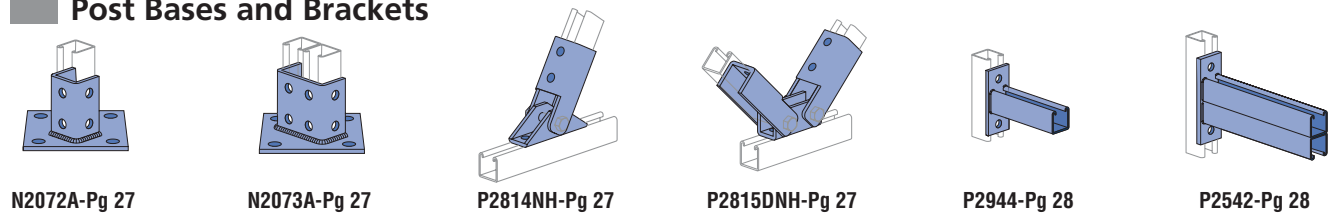

Beam Clamps

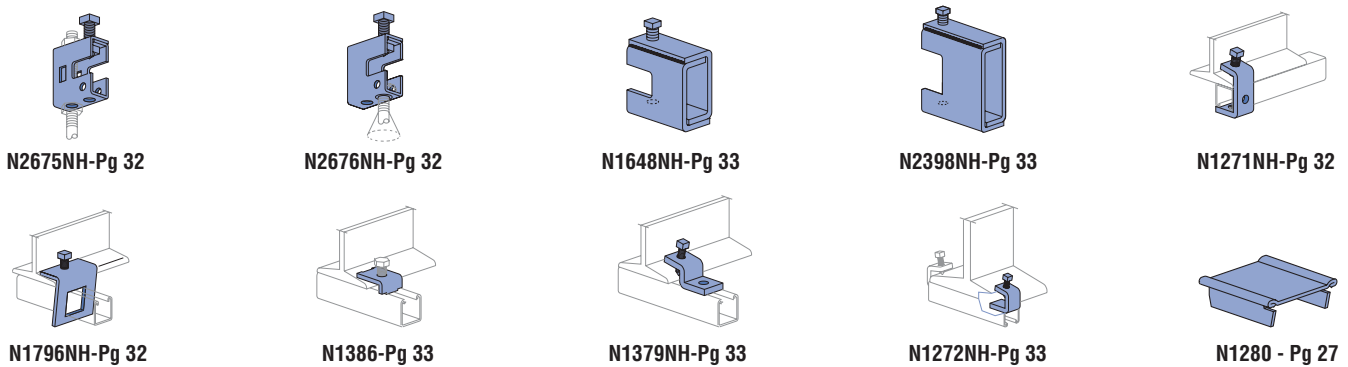



FRAMING MEMBERS

Unistrut channels and continuous inserts are accurately and carefully cold-formed to size from low carbon strip steel. One side of the channel has a continuous slot with inturred edges. Secure attachments may be made to the framing member with the use of hardened, toothed, slotted nuts which engage the inturred edges.

GAGE	FINISH	ASTM NO.
12	GR & HG	A1011SS GR 33
	PG	A653 GR 33
14	GR & HG	A1011SS GR 33
	PG	A653 GR 33

Raw steel shall conform to the following specifications.

FITTINGS

Unistrut fittings, unless noted otherwise, are punch-press made from hot rolled, pickled and oiled steel plates, strip, or coil and conform to ASTM specifications A575, A576. The fitting steel also meets the physical requirement of ASTM A1011SS GR 33. The pickling of the steel produces a smooth surface free from scale.

NUTS AND BOLTS

Unistrut nuts are made from steel coils or bars. After all machining operations are complete, they are thoroughly case hardened. Nuts are rectangular with ends shaped to permit a quarter turn clockwise in the framing member after insertion through the slotted opening in the channel. Two toothed grooves in the top of the nut engage the inturred edges of the channel and, after bolting operations are completed, will prevent any movement of the bolt and nut within the framing member. All bolts and nuts have Unified and American coarse screw threads. The standard framing nut is 1/2" and conforms to ASTM Specification A576 GR 1015 (modified). Machine screws & hex head screws conform to SAE J429 GR 2 (also meets and exceeds ASTM A307).

FINISHES

PERMA-GREEN® II (GR)

Channel and parts are carefully cleaned and phosphated. Immediately after phosphating, a uniform coat of a highly effective rust-inhibiting acrylic enamel paint is applied by electro-deposition and thoroughly baked. Color is Perma-Green per Federal Standard 595a color number 14109 (dark limit V-). The resulting finish will withstand 400 hours of salt spray when tested in accordance with ASTM designation B-117.

ELECTRO-GALVANIZED (EG)

Parts, screws and nuts are coated with zinc electrolytically to commercial standards (ASTM - B633 Type III SC1).

PRE-GALVANIZED (PG)

Material (steel strip) is coated with zinc by hot-dip process prior to roll-forming or press operations. The zinc coating weight is G90 conforming to ASTM Specification A653 GR 33.

HOT-DIPPED GALVANIZED (HG)

Material is coated with zinc after being roll-formed or after all manufacturing operations are completed, conforming to ASTM specification No. A123 for large items and A153 for centrifuged parts such as fasteners & small fittings.

SPECIAL METALS

Unistrut channel is also available in stainless steel per ASTM A240 (Type 304). Contact Unistrut for details.

WEIGHTS AND DIMENSIONS

Weights given for all materials are approximate shipping weights. All dimensions subject to commercial tolerance within published specifications.

COMMERCIAL GRADE

See Unistrut General Engineering Catalog for commercial grade products.

CRITICAL CHARACTERISTICS

For critical characteristics of Safety Related Products, see Section "C" of Unistrut's Quality Assurance Manual.

WE RESERVE THE RIGHT TO MAKE SPECIFICATION CHANGES WITHOUT NOTICE.

WHILE EVERY EFFORT HAS BEEN MADE TO ASSURE THE ACCURACY OF INFORMATION CONTAINED IN THIS CATALOG AT THE TIME OF PUBLICATION, WE CANNOT ACCEPT RESPONSIBILITY FOR INACCURACIES RESULTING FROM UNDETECTED ERRORS OR OMISSIONS.

THE BLUE COLOR USED ON UNISTRUT COMPONENTS ILLUSTRATED IN THIS CATALOG IS FOR GRAPHIC ENHANCEMENT ONLY, AND DOES NOT REPRESENT ACTUAL PRODUCT COLOR.

N1000® SERIES CHANNEL & COMBINATIONS

N1000

Weight: 190 Lbs/100 Ft (283 kg/100 m)

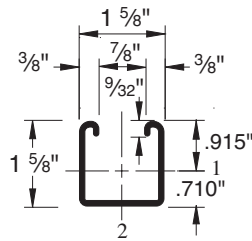
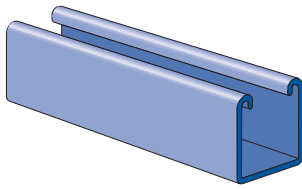

N1001

Weight: 380 Lbs/100 Ft (566 kg/100 m)

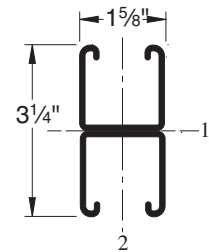
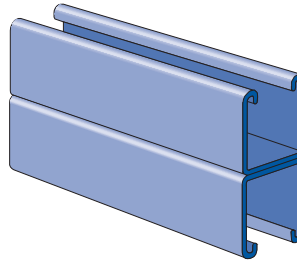

N1001 A

Weight: 380 Lbs/100 Ft (566 kg/100 m)

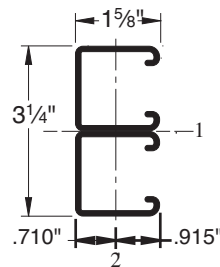
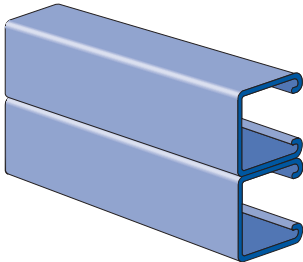

N1001 B

Weight: 380 Lbs/100 Ft (566 kg/100 m)

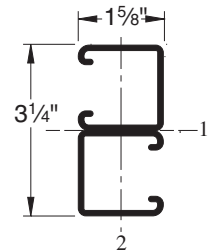
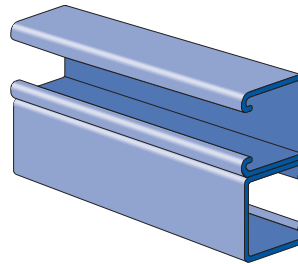

N1001 C

Weight: 380 Lbs/100 Ft (566 kg/100 m)

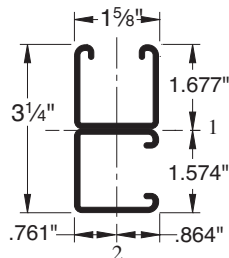
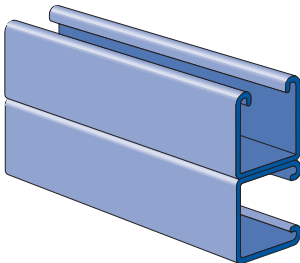

N1001 3

Weight: 570 Lbs/100 Ft (848 kg/100 m)

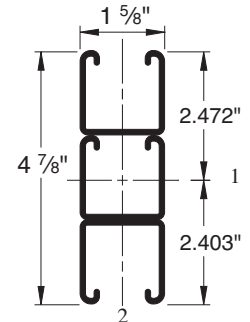
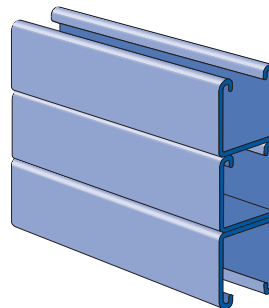

N1001 A3

Weight: 570 Lbs/100 Ft (848 kg/100 m)

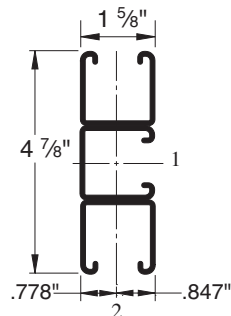
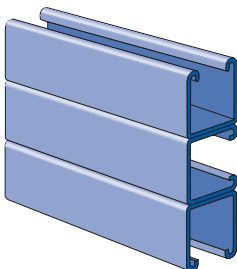

N1001 B3

Weight: 570 Lbs/100 Ft (848 kg/100 m)

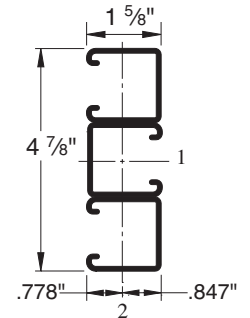
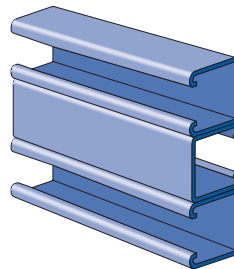

N1001 C3

Weight: 570 Lbs/100 Ft (848 kg/100 m)

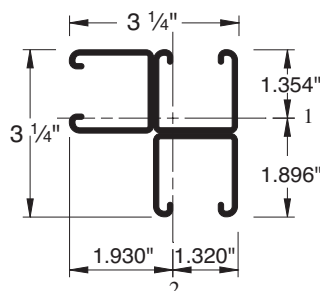
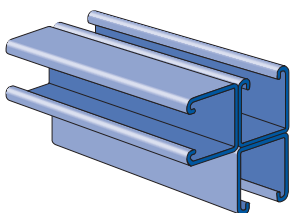

CHANNEL MATERIAL

- All single N1000 Series Unistrut channel members are accurately roll formed from 12 gauge (.105") strip steel.
- All multiple members are two or more single Unistrut members spot welded approximately 2" to 3" on center.
- Standard lengths of these channels are 10 and 20 feet (Nominal).



CHANNEL FINISHES

Channel	Finishes		
	GR	HG	PG
N1000	■	■	■
N1001	■	■	■
N1001 A	■	■	■
N1001 B	■	■	■
N1001 C	■	■	■
N1001 3	■	■	■
N1001 A3	■	■	■
N1001 B3	■	■	■
N1001 C3	■	■	■

Special finishes available upon request.

ELEMENTS OF SECTION

Channel	Area of		Axis 1-1			Axis 2-2		
	Wt./Ft. Lbs.	Sect. In. ²	I (In. ⁴)	S (In. ³)	r (In.)	I (In. ⁴)	S (In. ³)	r (In.)
N1000	1.89	0.556	0.185	0.202	0.577	0.236	0.290	0.651
N1001	3.78	1.112	0.930	0.572	0.915	0.472	0.580	0.651
N1001C3	5.67	1.667	1.410	0.744	0.920	1.515	0.785	0.953
N10013	3.78	1.112	0.930	0.572	0.915	0.472	0.580	0.651

I – Moment of Inertia; S – Section Modulus; r – Radius of Gyration

N1010 NUT STRENGTH (USED IN N1000 CHANNEL)

Resistance to Slip – 1500 Lbs. per bolt,
Pull Out Strength – 2000 Lbs. per bolt,
Includes a minimum Safety Factor of 3

BEAM AND COLUMN DATA

Loads calculated using AISI "Cold-Formed Steel Design Manual (1996 edition)." Due to changes introduced in this manual, values may differ from those shown in previous Unistrut Nuclear catalogs.

BEAM LOADING – N1000

Span In	Max Allowable Uniform Load	Defl. at Uniform Load	Uniform Loading at Defl.		
	Lbs	In	Span/180 Lbs	Span/240 Lbs	Span/360 Lbs
24	1,690	0.06	1,690	1,690	1,690
36	1,130	0.13	1,130	1,130	900
48	850	0.22	850	760	510
60	680	0.35	650	490	320
72	560	0.50	450	340	220
84	480	0.68	330	250	170
96	420	0.89	250	190	130
108	380	1.13	200	150	100
120	340	1.40	160	120	80

BEAM LOADING – N1001

Span In	Max Allowable Uniform Load	Defl. at Uniform Load	Uniform Loading at Defl.		
	Lbs	In	Span/180 Lbs	Span/240 Lbs	Span/360 Lbs
24	3,130 *	0.03	3,130 *	3,130 *	3,130 *
36	3,130 *	0.07	3,130 *	3,130 *	3,130 *
48	2,400	0.13	2,400	2,400	2,400
60	1,920	0.20	1,920	1,920	1,630
72	1,600	0.28	1,600	1,600	1,130
84	1,370	0.39	1,370	1,240	830
96	1,200	0.50	1,200	950	640
108	1,070	0.64	1,000	750	500
120	960	0.79	810	610	410

COLUMN LOADING – N1000

Unbraced Height In	Maximum Allowable Load at Slot Face Lbs	Maximum Col. Load Applied at C.G.			
		K = 0.65 Lbs	K = 0.80 Lbs	K = 1.0 Lbs	K = 1.2 Lbs
24	3,450	10,750	9,900	8,770	7,730
36	3,050	8,910	7,730	6,370	5,280
48	2,660	7,250	5,980	4,660	3,770
60	2,290	5,890	4,660	3,600	2,940
72	2,000	4,800	3,770	2,940	2,380
84	1,760	4,010	3,170	2,460	1,970
96	1,570	3,450	2,730	2,090	1,650
108	1,410	3,020	2,380	1,800	^{KL} / _r > 200
120	1,270	2,680	2,090	^{KL} / _r > 200	^{KL} / _r > 200

COLUMN LOADING – N1001

Unbraced Height In	Maximum Allowable Load at Slot Face Lbs	Maximum Col. Load Applied at C.G.			
		K = 0.65 Lbs	K = 0.80 Lbs	K = 1.0 Lbs	K = 1.2 Lbs
24	6,430	25,060	24,620	23,900	23,050
36	6,230	24,000	23,050	21,570	19,890
48	5,950	22,590	21,030	18,690	16,170
60	5,620	20,890	18,690	15,540	12,400
72	5,240	18,990	16,170	12,400	8,960
84	4,830	16,970	13,640	9,470	6,580
96	4,390	14,900	11,200	7,250	5,040
108	3,930	12,860	8,960	5,730	3,980
120	3,510	10,910	7,250	4,640	^{KL} / _r > 200

*Load limited by spot weld shear.

- Notes:**
1. Above loads include the weight of the member. This weight must be deducted to arrive at the net allowable load the beam will support.
 2. Long span beams should be supported in such a manner as to prevent rotation and twist. See Page 16
 3. Allowable uniformly distributed loads are listed for various simple spans, that is, a beam on two supports. If load is concentrated at the center of the span, multiply load from the table by 0.5 and corresponding deflection by 0.8.
 4. Column loadings are for allowable axial loads for the unsupported heights listed with a K value of 0.80.

N3000 & N3300 SERIES

N3000 Weight: 170 Lbs/100 Ft (253 kg/100 m)

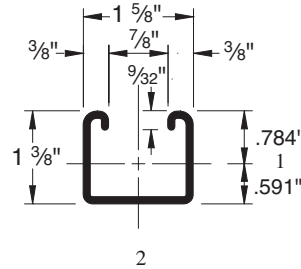
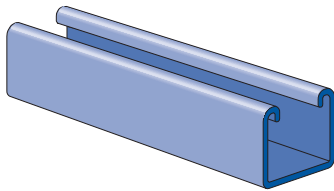

N3001 Weight: 340 Lbs/100 Ft (506 kg/100 m)

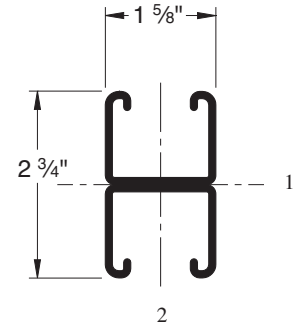
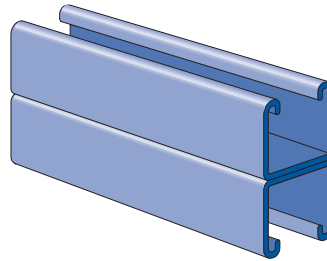

N3300 Weight: 135 Lbs/100 Ft (201 kg/100 m)

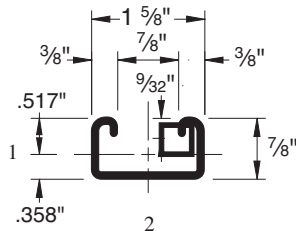
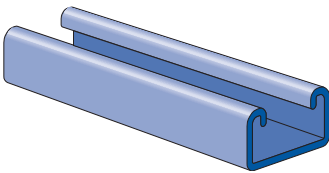

N3301 Weight: 270 Lbs/100 Ft (402 kg/100 m)

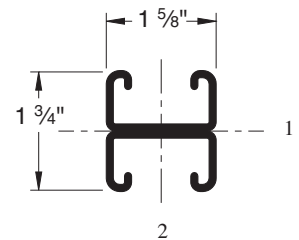
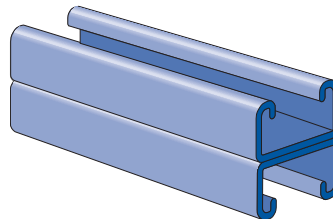

CHANNEL MATERIAL

- All single N3000 and N3300 Series Unistrut channel members are accurately roll formed from 12 gauge (.105") strip steel.
- All multiple members are two or more single Unistrut members spot welded approximately 2" to 3" on center.
- Standard lengths of these channels are 10 and 20 feet (Nominal).

CHANNEL FINISHES

Channel	Finishes		
	GR	HG	PG
N3000	■	■	■
N3001	■	■	■
N3300	■	■	■
N3301	■	■	■

Special finishes available upon request.

ELEMENTS OF SECTION

Channel	Area of		Axis 1-1				Axis 2-2			
	Wt./Ft.	Sect.	I (In. ⁴)	S (In. ³)	r (In.)	I (In. ⁴)	S (In. ³)	r (In.)		
N3000	1.71	0.503	0.121	0.154	0.490	0.205	0.253	0.639		
N3001	3.42	1.007	0.593	0.431	0.767	0.411	0.506	0.639		
N3300	1.35	0.398	0.037	0.072	0.306	0.145	0.178	0.603		
N3301	2.71	0.797	0.177	0.202	0.471	0.289	0.356	0.603		

I – Moment of Inertia; S – Section Modulus; r – Radius of Gyration

N1010 NUT STRENGTH (USED IN N3000 CHANNEL)

Resistance to Slip – 1500 Lbs. per bolt,
Pull Out Strength – 2000 Lbs. per bolt,
Includes a minimum Safety Factor of 3

N4010 NUT STRENGTH (USED IN N3300 CHANNEL)

Resistance to Slip – 1500 Lbs. per bolt,
Pull Out Strength – 1500 Lbs. per bolt,
Includes a minimum Safety Factor of 3



BEAM AND COLUMN DATA

Loads calculated using AISI "Cold-Formed Steel Design Manual (1996 edition)." Due to changes introduced in this manual, values may differ from those shown in previous Unistrut Nuclear catalogs.

BEAM LOADING – N3000

Span In	Max Defl. at		Uniform Loading at Defl.		
	Allowable Uniform Load Lbs	Uniform Load In	Span/180 Lbs	Span/240 Lbs	Span/360 Lbs
24	1,290	0.07	1,290	1,290	1,290
36	860	0.15	860	860	590
48	650	0.26	650	500	330
60	520	0.41	420	320	210
72	430	0.59	290	220	150
84	370	0.80	220	160	110
96	320	1.04	170	120	80
108	290	1.32	130	100	70
120	260	1.63	110	80	50

BEAM LOADING – N3001

Span In	Max Defl. at		Uniform Loading at Defl.		
	Allowable Uniform Load Lbs	Uniform Load In	Span/180 Lbs	Span/240 Lbs	Span/360 Lbs
24	2,660 *	0.04	2,660 *	2,660 *	2,660 *
36	2,410	0.08	2,410	2,410	2,410
48	1,810	0.15	1,810	1,810	1,620
60	1,450	0.23	1,450	1,450	1,040
72	1,200	0.33	1,200	1,080	720
84	1,030	0.46	1,030	790	530
96	900	0.59	810	610	400
108	800	0.75	640	480	320
120	720	0.93	520	390	260

COLUMN LOADING – N3000

Unbraced Height In	Maximum Allowable Load at Slot Face Lbs	Max. Col. Load Applied at C.G.			
		K = 0.65 Lbs	K = 0.80 Lbs	K = 1.0 Lbs	K = 1.2 Lbs
24	3,070	9,790	9,090	8,190	7,370
36	2,730	8,300	7,370	6,320	5,440
48	2,400	7,000	6,010	4,930	4,050
60	2,090	5,930	4,930	3,860	3,120
72	1,820	5,060	4,050	3,120	2,290
84	1,590	4,300	3,390	2,430	$KL/r > 200$
96	1,400	3,690	2,880	1,860	$KL/r > 200$
108	1,200	3,220	2,290	$KL/r > 200$	$KL/r > 200$
120	1,040	2,820	1,860	$KL/r > 200$	$KL/r > 200$

COLUMN LOADING – N3001

Unbraced Height In	Maximum Allowable Load at Slot Face Lbs	Max. Col. Load Applied at C.G.			
		K = 0.65 Lbs	K = 0.80 Lbs	K = 1.0 Lbs	K = 1.2 Lbs
24	5,720	22,670	22,250	21,580	20,780
36	5,500	21,670	20,780	19,400	17,830
48	5,220	20,350	18,890	16,710	14,390
60	4,880	18,760	16,710	13,800	10,920
72	4,510	17,000	14,390	10,920	7,810
84	4,120	15,120	12,050	8,270	5,740
96	3,710	13,210	9,820	6,330	4,400
108	3,300	11,340	7,810	5,000	$KL/r > 200$
120	2,940	9,560	6,330	4,050	$KL/r > 200$

BEAM LOADING – N3300

Span In	Max Defl. at		Uniform Loading at Defl.		
	Allowable Uniform Load Lbs	Uniform Load In	Span/180 Lbs	Span/240 Lbs	Span/360 Lbs
24	600	0.10	600	600	400
36	400	0.22	360	270	180
48	300	0.40	200	150	100
60	240	0.62	130	100	60
72	200	0.90	90	70	40
84	170	1.22	70	50	30
96	150	1.59	50	40	30
108	130	2.02	40	30	20
120	120	2.49	30	20	20

BEAM LOADING – N3301

Span In	Max Defl. at		Uniform Loading at Defl.		
	Allowable Uniform Load Lbs	Uniform Load In	Span/180 Lbs	Span/240 Lbs	Span/360 Lbs
24	1,660 *	0.06	1,660 *	1,660 *	1,660 *
36	1,130	0.13	1,130	1,130	860
48	850	0.23	850	730	480
60	680	0.36	620	460	310
72	560	0.53	430	320	210
84	480	0.72	320	240	160
96	420	0.93	240	180	120
108	380	1.18	190	140	100
120	340	1.46	150	120	80

COLUMN LOADING – N3300

Unbraced Height In	Maximum Allowable Load at Slot Face Lbs	Max. Col. Load Applied at C.G.			
		K = 0.65 Lbs	K = 0.80 Lbs	K = 1.0 Lbs	K = 1.2 Lbs
24	2,120	7,710	7,190	6,410	5,440
36	1,760	6,520	5,440	4,030	2,830
48	1,380	4,960	3,590	2,290	1,590
60	1,060	3,480	2,290	1,470	$KL/r > 200$
72	840	2,410	1,590	$KL/r > 200$	$KL/r > 200$
84	$KL/r > 200$	1,770	$KL/r > 200$	$KL/r > 200$	$KL/r > 200$

COLUMN LOADING – N3301

Unbraced Height In	Maximum Allowable Load at Slot Face Lbs	Max. Col. Load Applied at C.G.			
		K = 0.65 Lbs	K = 0.80 Lbs	K = 1.0 Lbs	K = 1.2 Lbs
24	4,130	17,400	16,820	15,900	14,840
36	3,810	16,020	14,840	13,070	11,190
48	3,420	14,270	12,450	9,930	7,540
60	3,000	12,290	9,930	6,970	4,840
72	2,590	10,250	7,540	4,840	3,360
84	2,200	8,260	5,550	3,550	$KL/r > 200$
96	1,890	6,440	4,250	$KL/r > 200$	$KL/r > 200$
108	1,630	5,090	3,360	$KL/r > 200$	$KL/r > 200$
120	$KL/r > 200$	4,120	$KL/r > 200$	$KL/r > 200$	$KL/r > 200$

- Notes:**
- Above loads include the weight of the member. This weight must be deducted to arrive at the net allowable load the beam will support.
 - Long span beams should be supported in such a manner as to prevent rotation and twist. See Page 16.
 - Allowable uniformly distributed loads are listed for various simple spans, that is, a beam on two supports. If load is concentrated at the center of the span, multiply load from the table by 0.5 and corresponding deflection by 0.8.
 - Column loadings are for allowable axial loads for the unsupported heights listed with a K value of 0.80.

*Load limited by spot weld shear.

N5000 & N5500 SERIES CHANNEL & COMBINATIONS

N5000

Weight: 305 Lbs/100 Ft (454 kg/100 m)

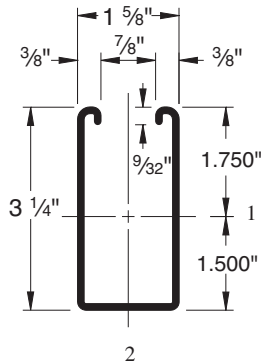
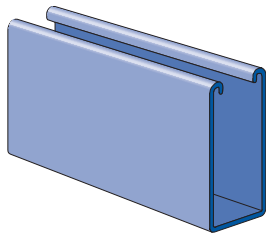

N5001

Weight: 610 Lbs/100 Ft (908 kg/100 m)

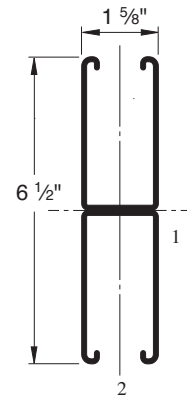
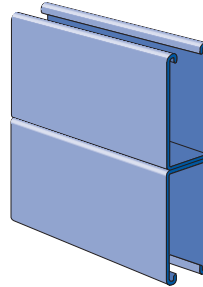

N5500

Weight: 247 Lbs/100 Ft (368 kg/100 m)

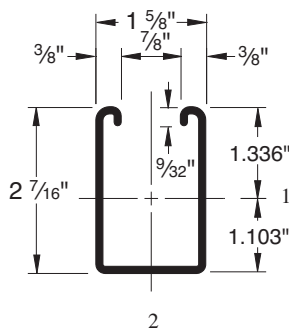
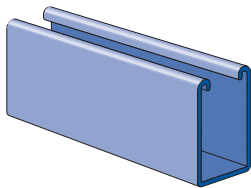

N5501

Weight: 494 Lbs/100 Ft (735 kg/100 m)

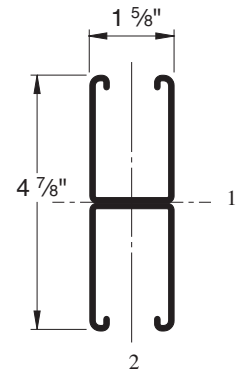
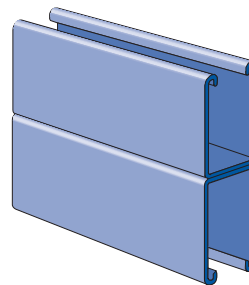

CHANNEL FINISHES

Channel	Finishes		
	GR	HG	PG
N5000	■	■	■
N5001	■	■	■
N5500	■	■	■
N5501	■	■	■

Special finishes available upon request.

ELEMENTS OF SECTION

Channel	Wt./Ft. Lbs.	Area of Sect. in. ²	Axis 1-1			Axis 2-2		
			I (in. ⁴)	S (in. ³)	r (in.)	I (in. ⁴)	S (in. ³)	r (in.)
N5000	3.05	0.897	1.099	0.628	1.107	0.433	0.533	0.695
N5001	6.10	1.794	6.234	1.918	1.864	0.866	1.066	0.695
N5500	2.47	0.726	0.523	0.391	0.848	0.335	0.412	0.679
N5501	4.94	1.453	2.811	1.153	1.391	0.669	0.824	0.679

I – Moment of Inertia; S – Section Modulus; r – Radius of Gyration

CHANNEL MATERIAL

- All single N5000 and N5500 Series Unistrut channel members are accurately roll formed from 12 gauge (.105") strip steel.
- All multiple members are two or more single Unistrut members spot welded approximately 2" to 3" on center.
- Standard lengths of these channels are 10 and 20 feet (Nominal).

N3010 NUT STRENGTH (USED IN N5000 CHANNEL)

Resistance to Slip – 1500 Lbs. per bolt,
Pull Out Strength – 2000 Lbs. per bolt,
Includes a minimum Safety Factor of 3

N5510 NUT STRENGTH (USED IN N5500 CHANNEL)

Resistance to Slip – 1500 Lbs. per bolt,
Pull Out Strength – 2000 Lbs. per bolt,
Includes a minimum Safety Factor of 3



BEAM AND COLUMN DATA

Loads calculated using AISI "Cold-Formed Steel Design Manual (1996 edition)." Due to changes introduced in this manual, values may differ from those shown in previous Unistrut Nuclear catalogs.

BEAM LOADING – N5000

Span In	Max Allowable Uniform Load Lbs	Defl. at Uniform Load In	Uniform Loading at Defl.		
			Span/180 Lbs	Span/240 Lbs	Span/360 Lbs
24	5,260	0.03	5,260	5,260	5,260
36	3,510	0.07	3,510	3,510	3,510
48	2,630	0.12	2,630	2,630	2,630
60	2,110	0.18	2,110	2,110	1,920
72	1,750	0.26	1,750	1,750	1,330
84	1,500	0.36	1,500	1,470	980
96	1,320	0.47	1,320	1,130	750
108	1,170	0.59	1,170	890	590
120	1,050	0.73	960	720	480
144	880	1.05	670	500	330
168	750	1.43	490	370	250
192	660	1.87	380	280	190
216	580	2.37	300	220	150
240	530	2.92	240	180	120

BEAM LOADING – N5001

Span In	Max Allowable Uniform Load Lbs	Defl. at Uniform Load In	Uniform Loading at Defl.		
			Span/180 Lbs	Span/240 Lbs	Span/360 Lbs
24	6,170 *	0.02	6,170 *	6,170 *	6,170 *
36	6,170 *	0.04	6,170 *	6,170 *	6,170 *
48	6,170 *	0.06	6,170 *	6,170 *	6,170 *
60	6,170 *	0.10	6,170 *	6,170 *	6,170 *
72	5,360	0.14	5,360	5,360	5,360
84	4,590	0.19	4,590	4,590	4,590
96	4,020	0.25	4,020	4,020	4,020
108	3,570	0.32	3,570	3,570	3,360
120	3,220	0.39	3,220	3,220	2,720
144	2,680	0.57	2,680	2,680	1,890
168	2,300	0.77	2,300	2,090	1,390
192	2,010	1.01	2,010	1,600	1,060
216	1,790	1.27	1,680	1,260	840
240	1,610	1.57	1,360	1,020	680

COLUMN LOADING – N5000

Unbraced Height In	Max. Allowable Load at Slot Face Lbs	Max. Col. Load Applied at C.G.			
		K = 0.65 Lbs	K = 0.80 Lbs	K = 1.0 Lbs	K = 1.2 Lbs
24	4,430	13,050	12,000	11,180	9,590
36	4,030	11,380	9,590	7,390	5,560
48	3,400	8,830	6,730	4,700	3,560
60	2,780	6,580	4,700	3,360	2,620
72	2,330	4,890	3,560	2,620	2,090
84	2,010	3,860	2,870	2,160	1,750
96	1,770	3,180	2,410	1,850	1,510
108	1,590	2,710	2,090	1,620	1,330
120	1,440	2,370	1,850	1,450	**

COLUMN LOADING – N5001

Unbraced Height In	Max. Allowable Load at Slot Face Lbs	Max. Col. Load Applied at C.G.			
		K = 0.65 Lbs	K = 0.80 Lbs	K = 1.0 Lbs	K = 1.2 Lbs
24	8,360	30,190	29,820	29,220	28,500
36	8,230	29,300	28,500	27,220	25,740
48	8,050	28,100	26,750	24,660	22,320
60	7,810	26,630	24,660	23,090	19,770
72	7,530	24,930	22,320	19,770	15,800
84	7,340	23,070	21,110	16,450	12,100
96	6,950	22,440	18,430	13,300	9,260
108	6,510	20,270	15,800	10,540	7,320
120	6,010	18,100	13,300	8,540	^{KL} / _r > 200

BEAM LOADING – N5500

Span In	Max Allowable Uniform Load Lbs	Defl. at Uniform Load In	Uniform Loading at Defl.		
			Span/180 Lbs	Span/240 Lbs	Span/360 Lbs
24	3,280	0.04	3,280	3,280	3,280
36	2,190	0.09	2,190	2,190	2,190
48	1,640	0.15	1,640	1,640	1,430
60	1,310	0.24	1,310	1,310	910
72	1,090	0.34	1,090	950	630
84	940	0.47	930	700	470
96	820	0.61	710	540	360
108	730	0.77	560	420	280
120	660	0.96	460	340	230
144	550	1.38	320	240	160
168	470	1.87	230	170	120
192	410	2.45	180	130	90
216	360	3.10	140	110	70
240	330	3.82	110	90	60

BEAM LOADING – N5501

Span In	Max Allowable Uniform Load Lbs	Defl. at Uniform Load In	Uniform Loading at Defl.		
			Span/180 Lbs	Span/240 Lbs	Span/360 Lbs
24	4,680 *	0.02	4,680 *	4,680 *	4,680 *
36	4,680 *	0.05	4,680 *	4,680 *	4,680 *
48	4,680 *	0.08	4,680 *	4,680 *	4,680 *
60	3,870	0.13	3,870	3,870	3,870
72	3,220	0.19	3,220	3,220	3,220
84	2,760	0.26	2,760	2,760	2,510
96	2,420	0.34	2,420	2,420	1,920
108	2,150	0.42	2,150	2,150	1,520
120	1,930	0.52	1,930	1,840	1,230
144	1,610	0.76	1,610	1,280	850
168	1,380	1.03	1,250	940	630
192	1,210	1.34	960	720	480
216	1,070	1.70	760	570	380
240	970	2.10	610	460	310

COLUMN LOADING – N5500

Unbraced Height In	Max. Allowable Load at Slot Face Lbs	Max. Col. Load Applied at C.G.			
		K = 0.65 Lbs	K = 0.80 Lbs	K = 1.0 Lbs	K = 1.2 Lbs
24	4,580	13,860	12,610	10,910	9,300
36	4,010	11,120	9,300	7,190	5,550
48	3,370	8,550	6,580	4,800	3,800
60	2,810	6,430	4,800	3,610	2,920
72	2,410	4,970	3,800	2,920	2,390
84	2,120	4,060	3,160	2,460	2,020
96	1,900	3,450	2,720	2,130	1,740
108	1,720	3,000	2,390	1,870	1,520
120	1,570	2,670	2,130	1,660	^{KL} / _r > 200

COLUMN LOADING – N5501

Unbraced Height In	Max. Allowable Load at Slot Face Lbs	Max. Col. Load Applied at C.G.			
		K = 0.65 Lbs	K = 0.80 Lbs	K = 1.0 Lbs	K = 1.2 Lbs
24	8,650	32,840	32,310	31,440	30,410
36	8,450	31,560	30,410	28,610	26,550
48	8,180	29,850	27,950	25,070	21,960
60	7,830	27,780	25,070	21,160	17,200
72	7,420	25,450	21,960	17,200	12,730
84	6,940	22,950	18,770	13,460	9,350
96	6,410	20,360	15,660	10,310	7,160
108	5,810	17,780	12,730	8,150	5,660
120	5,220	15,280	10,310	6,600	^{KL} / _r > 200

- Notes:**
- Above loads include the weight of the member. This weight must be deducted to arrive at the net allowable load the beam will support.
 - Long span beams should be supported in such a manner as to prevent rotation and twist. See Page 16.
 - Allowable uniformly distributed loads are listed for various simple spans, that is, a beam on two supports. If load is concentrated at the center of the span, multiply load from the table by 0.5 and corresponding deflection by 0.8.
 - Column loadings are for allowable axial loads for the unsupported heights listed with a K value of 0.80.

*Load limited by spot weld shear. #: Bearing load may govern capacity. See Page 16.

CHANNELS WITH SLOTS OR HOLES

"T" SERIES – SLOTTED

Standard Lengths: 10' and 20'.

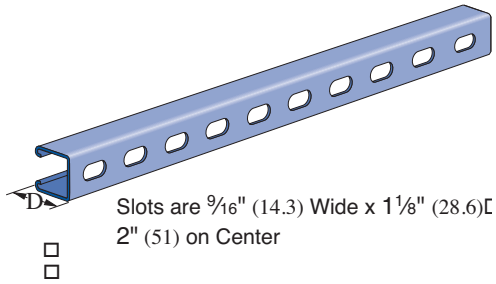

Part Number	Depth "D"		Material Thicknesses		Weight	
	In.	mm.	In.	mm.	Lbs/100 Ft.	kg/100 m
N1000 T	$1\frac{5}{8}$	41	.105	2.7	185	275
N3000 T	$1\frac{3}{8}$	35	.105	2.7	165	245
N3300 T	$\frac{7}{8}$	22	.105	2.7	130	193
N5000 T	$3\frac{1}{4}$	82	.105	2.7	300	446
N5500 T	$2\frac{7}{16}$	62	.105	2.7	242	360

Note: For beam load capacity, use 85% of appropriate load chart.

"HS" SERIES – HOLES

Standard Lengths: 10' and 20'.

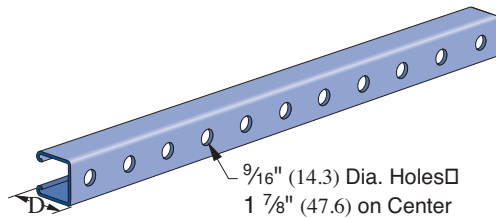

Part Number	Depth "D"		Material Thicknesses		Weight	
	In.	mm.	In.	mm.	Lbs/100 Ft.	kg/100 m
N1000 HS	$1\frac{5}{8}$	41	.105	2.7	185	275
N3000 HS	$1\frac{3}{8}$	35	.105	2.7	165	246
N3300 HS	$\frac{7}{8}$	22	.105	2.7	130	193
N5000 HS	$3\frac{1}{4}$	82	.105	2.7	300	446
N5500 HS	$2\frac{7}{16}$	62	.105	2.7	242	360

Note: For beam load capacity, use 95% of appropriate load chart.



LATERAL BRACING LOAD REDUCTION CHARTS

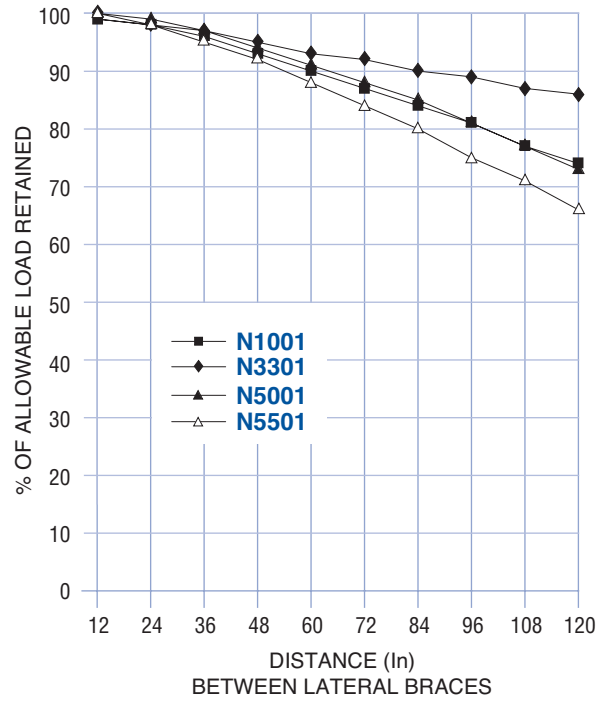
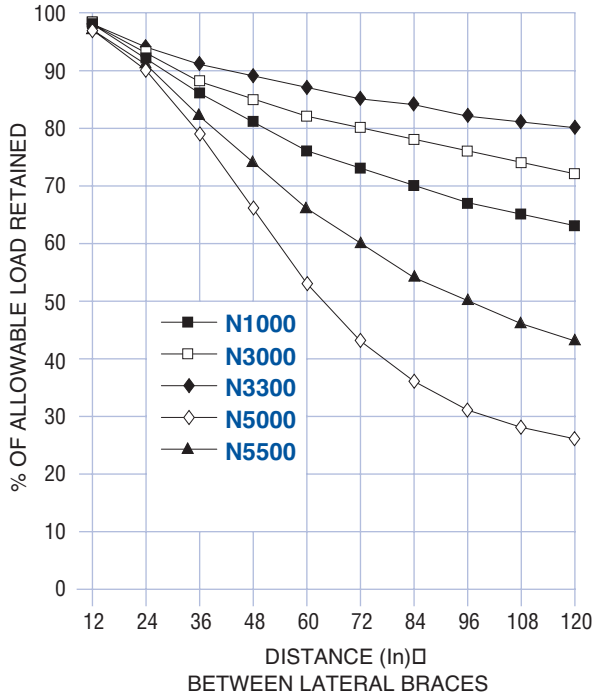

BEARING LOADS ON UNISTRUT CHANNEL

Safety Factor — 2½	Bearing Length 1½" (41 mm)		Bearing Length 1½" (41 mm)		Bearing Length ¾" (82 mm)	
	Maximum Allowable Loads		Maximum Allowable Loads		Maximum Allowable Loads	
Channel	Lbs	Kn	Lbs	Kn	Lbs	Kn
N1000	5,000	22.2	3,500	15.6	8,000	35.6
N3000	5,000	22.2	3,500	15.6	8,000	35.6
N3300	6,000	26.7	4,000	17.8	9,000	35.6
N5000	4,000	17.8	2,000	8.9	5,500	24.6
N5500	5,000	22.2	3,500	15.6	8,000	35.6

DESIGN LOAD DATA FOR TYPICAL UNISTRUT CHANNEL CONNECTIONS

Channel Thickness	N1026		90° Fittings (When used in position shown)		N1325		N1458		N1346	
	Lbs	kN	Lbs	kN	Lbs	kN	Lbs	kN	Lbs	kN
12 ga.	1500	6.7	1000	4.4	2000	8.9	1500	6.7	2000	8.9

Channel Thickness	N2484		90° Fittings (When used in position shown)		N1068		N1326		N1346		N1065	
	Lbs	kN	Lbs	kN	Lbs	kN	Lbs	kN	Lbs	kN	Lbs	kN
12 ga.	3000	13.3	500	2.2	500	2.2	1200	5.3	1000	4.4		

Both ends of beams supported.

Load data is based on N1010 nut and 1/2" bolt.

Safety factor = 2 1/2 based on ultimate strength of connection.



MATERIAL

Unistrut spring or springless nuts are manufactured from mild steel bars, and after machining operations are completed, they are case hardened. Hardening assures positive biting action into the inturned edge of the Unistrut channel. Nuts, bolts & washers are electro-galvanized, unless otherwise noted.

THREADS

All threads on the nuts & bolts are Unified & American screw threads, UNC classes 2A & 2B. The threads on Unistrut nuts are accepted at .002" over the 2B maximum limit.

DESIGN BOLT TORQUE

BOLT SIZE	1/4"	3/8"	1/2"	5/8"	3/4"
FOOT LBS.	6	19	50	100	125
N·m	8	25	70	135	170

N1006-1420 THRU N1023S

Channel Nuts with Springs

Part Number	Size & Thread	Weight/100 pcs.
	lbs.	kg
N1006-1420	1/4"	- 20 7 3.2
N1008	3/8"	- 16 10 4.5
N1010	1/2"	- 13 12 5.4

Note: Use with N1000 & N3000 channels.

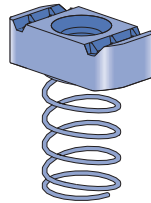

Part Number	Size & Thread	Weight/100 pcs.
	lbs.	kg
N1012S	5/8"	- 11 21 9.5
N1023S	3/4"	- 10 21 9.5

Note: Use with N1000 & N3000 channels.

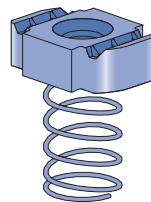

N4006-1420 THRU N4010S

Channel Nuts with Springs

Part Number	Size & Thread	Weight/100 pcs.
	lbs.	kg
N4006-1420	1/4"	- 20 7 3.2
N4008	3/8"	- 16 9 4.1
N4010	1/2" - 13	8 3.6

Note: Use with N3300 channels.

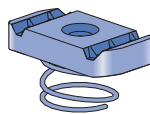

N5506-1420 THRU N5510

Channel Nuts with Springs

Part Number	Size & Thread	Weight/100 pcs.
	lbs.	kg
N5506-1420	1/4"	- 20 7 3.2
N5508	3/8"	- 16 10 4.5
N5510	1/2" - 13	12 5.4

Note: Use with N5500 channels.

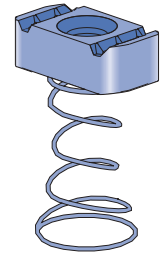

N3006-1420 – N3010

Channel Nuts without Springs

Part Number	Size & Thread	Weight/100 pcs.
	lbs.	kg
N3006-1420	1/4"	- 20 6 2.7
N3008	3/8"	- 16 9 4.1
N3010*	1/2" -13	8 3.6

Note: Use With N1000, N3000, N3300, N5000 and N5500 Channels.

* Not for use with N3300

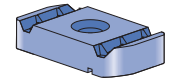

N1012 – N1023

Channel Nuts without Springs

Part Number	Size & Thread	Weight/100 pcs.
	lbs.	kg
N1012	5/8" -11	20 9.1
N1023	3/4" -10	20 9.1

Note: Use with N1000, N3000, N5000 & N5500 channels.

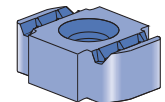

N4012 – N4023

Channel Nuts without Springs

Part Number	Size & Thread	Weight/100 pcs.
	lbs.	kg
N4012	5/8" -11	10 4.5
N4023	3/4" -10	10 4.5

Note: Use with N3300 channels.

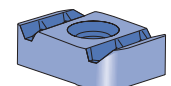

HEX HEAD CAP SCREWS

Part Number	Size	Weight/100 pcs.	
		lbs.	kg
NHCS025100EG	1/4" x 1"	1.5	0.7
NHCS037100EG	3/8" x 1"	4.5	2.0
NHCS050094EG	1/2" x 1 5/16"	9.1	4.1
NHCS050150EG	1/2" x 1 1/2"	11.6	5.3

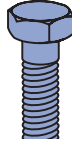

LOCK WASHERS

Part Number	Size	Weight/100 pcs.	
		lbs.	kg
NLKW025EG	1/4"	0.25	0.1
NLKW037EG	3/8"	0.63	0.3
NLKW050EG	1/2"	1.32	0.6

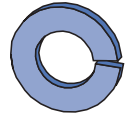

CONE POINT SET SCREWS

Part Number	Size	Weight/100 pcs.	
		lbs.	kg
NCSS037150EG	3/8" x 1 1/2"	6.0	2.7
NCSS037200EG	3/8" x 2"	6.1	2.8
NCSS050150EG	1/2" x 1 1/2"	8.5	3.9
NCSS050200EG	1/2" x 2"	11.4	5.2

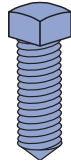

FLAT WASHERS

Part Number	Size	Weight/100 pcs.	
		lbs.	kg
NFLW025EG	1/4"	0.8	0.4
NFLW037EG	3/8"	1.5	0.7
NFLW050EG	1/2"	3.5	1.6

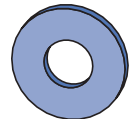

HEXAGON NUTS

Part Number	Size	Weight/100 pcs.	
		lbs.	kg
NHXN025EG	1/4"	0.6	0.3
NHXN037EG	3/8"	1.6	0.7
NHXN050EG	1/2"	4.8	2.2



STEEL THREADED ROD

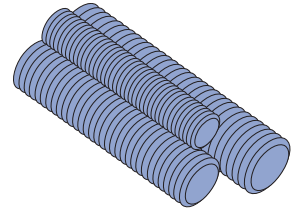

Part Number	Size	Weight/100 pcs.	
		lbs.	kg
NTHR025	1/4" x 20	13	5.9
NTHR037	3/8" x 16	30	13.6
NTHR050	1/2" x 13	53	24.0

Note: Standard 10' length

HEX SLOTTED MACHINE SCREWS

Part Number	Size	Weight/100 pcs.	
		lbs.	kg
NSHS025075EG	1/4" x 3/4"	1.7	0.8
NSHS025100EG	1/4" x 1"	1.8	0.9
NSHS025125EG	1/4" x 1 1/4"	2.5	1.1
NSHS031100EG	5/16" x 1"	2.6	1.2
NSHS031125EG	5/16" x 1 1/4"	3.0	1.4
NSHS031137EG	5/16" x 1 3/8"	3.3	1.6
NSHS031175EG	5/16" x 1 3/4"	3.6	1.8
NSHS037125EG	3/8" x 1 1/4"	5.3	2.4

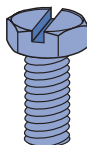



MATERIAL

Unless otherwise noted, all Unistrut fittings are punch press formed from hot rolled pickled and oiled plate or strip steel and conform to ASTM specifications A575 and A576.

STANDARD DIMENSIONS

The following dimensions apply to all fittings except as noted on the part drawings:

- Fitting width: 1-5/8"
- Fitting thickness: 1/4"
- Hole size: 9/16" Diameter
- Hole spacing:
13/16" from end of fitting &
1-7/8" center to center

DESIGN LOAD DATA

Design load data, where shown, is based on the ultimate strength of the connection with a safety factor of 2-1/2.

FITTING APPLICATION

All part drawings illustrate only one application of each fitting. In most cases many other applications are possible. The Unistrut members shown in the illustration are N1000, 1 5/8" square, except where noted otherwise. All 9/16" diameter holes use 1/2" x 1 5/16" hex head cap screws and 1/2" Unistrut nuts – N1010 or N5510 – depending on the Unistrut channel used. Nuts & bolts are not included with the fitting and must be ordered separately.

DESIGN BOLT TORQUE

BOLT SIZE	1/4"	3/8"	1/2"	5/8"	3/4"
	20	16	13	11	10
FOOT LBS.	6	19	50	100	125
N·m	8	25	70	135	170

FINISHES

All fittings in this section are available in:

- Perma-Green (GR),
- Hot Dipped Galvanized (HG)
- Electro Galvanized (EG).

Many fittings are also available in Stainless Steel (SS). Contact Unistrut for Availability.

**N1062 THRU N1064
N1964, N2471, N2490**

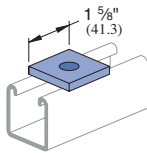

Standard Square Washer

Part Number	Bolt Size	Hole Size	Wt./100 pcs.	
			lbs.	kg
N1062	5/16"	11/32"	18	8.2
N1063	3/8"	7/16"	18	8.2
N1064	1/2"	9/16"	17	7.7
N2471	3/4"	13/16"	15	6.8

N2862 THRU N2864

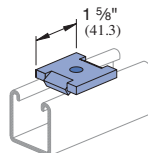

Anti-Rotation Washer

Part Number	Bolt Size	Hole Size	Wt./100 pcs.	
			lbs.	kg
N2862	5/16"	11/32"	18	8.2
N2863	3/8"	7/16"	18	8.2
N2864	1/2"	9/16"	17	7.7

N1959 THRU N1961

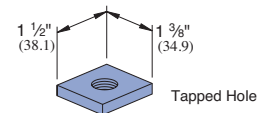

Material 3/8" (9.5) thick.

Tapped Square Plate

Part Number	US Std. Thd. Size	Wt./100 pcs.	
		lbs.	kg
N1959	3/8" - 16	21	9.5
N1960	1/2" - 13	20	9.1
N1961	5/8" - 11	19	8.6

N1028

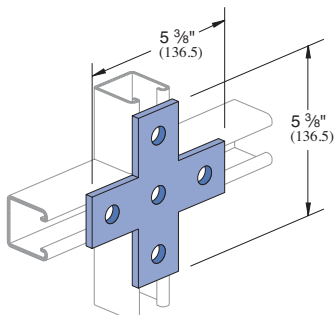

Weight: 105 Lbs/100 Pcs (47.6 kg)

N1031

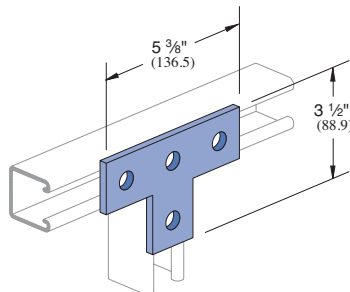

Weight: 80 Lbs/100 Pcs (36.3 kg)

N1036

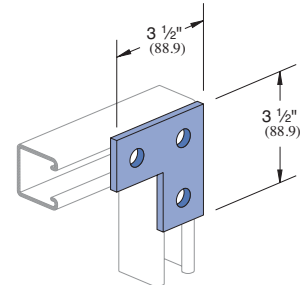

Weight: 58 Lbs/100 Pcs (26.3 kg)

N1065

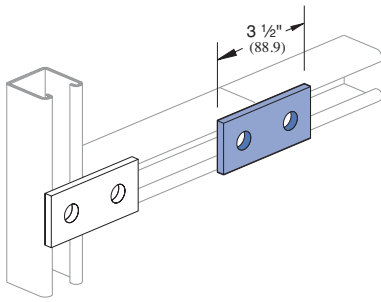

Weight: 38 Lbs/100 Pcs (17.2 kg)

N1066

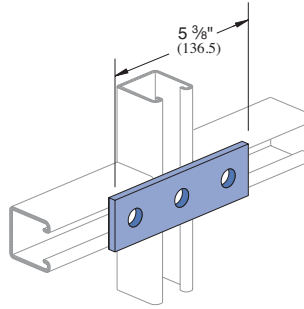

Weight: 56 Lbs/100 Pcs (25.4 kg)

N1067

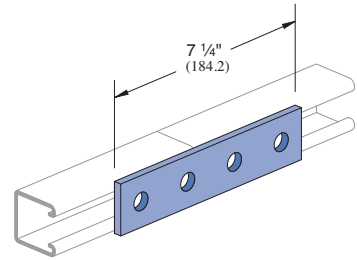

Weight: 78 Lbs/100 (35.4kg)

N1356

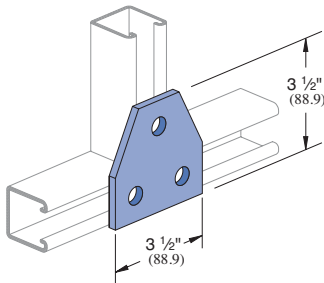

Weight: 70 Lbs/100 Pcs (31.8 kg)

N1358

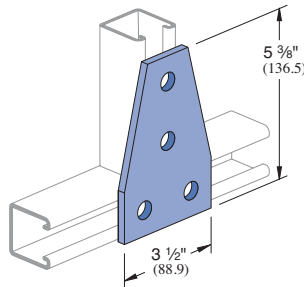

Weight: 105 Lbs/100 Pcs (47.6 kg)

N1380 A

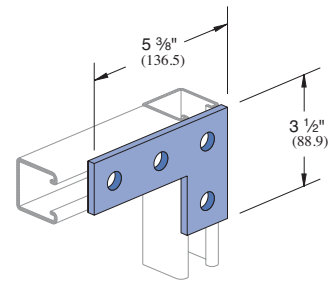

Weight: 80 Lbs/100 Pcs (36.3 kg)

N1380

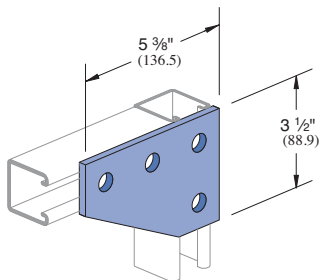

Weight: 105 Lbs/100 Pcs (47.6 kg)

N1726

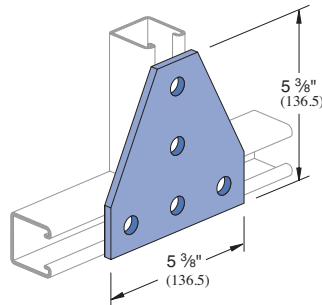

Weight: 148 Lbs/100 Pcs (67.1 kg)

N1873

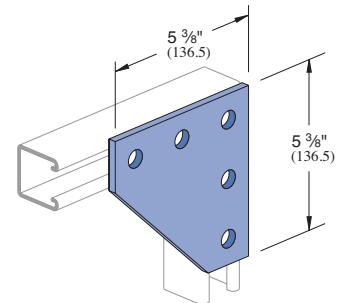

Weight: 150 Lbs/100 Pcs (68.0 kg)

N1924

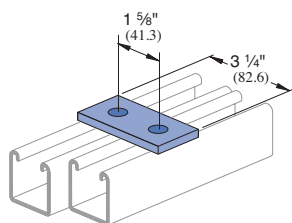

Weight: 35 Lbs/100 Pcs (15.9 kg)

N1925

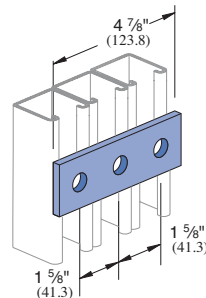

Weight: 50 Lbs/100 Pcs (22.7 kg)

N1941

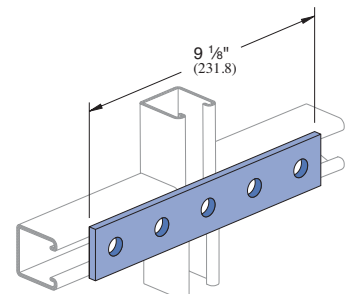

Weight: 94 Lbs/100 Pcs (42.6 kg)



N1950

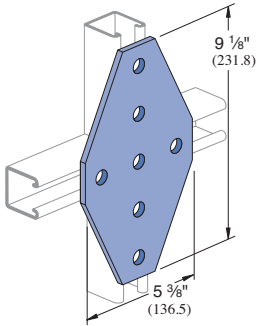

Weight: 240 Lbs/100 Pcs (108.9 kg)

N2079

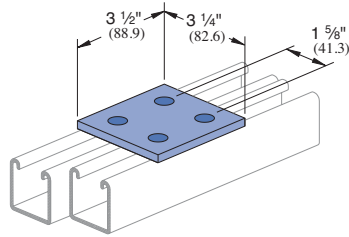

Weight: 73 Lbs/100 Pcs (33.1 kg)

N2324

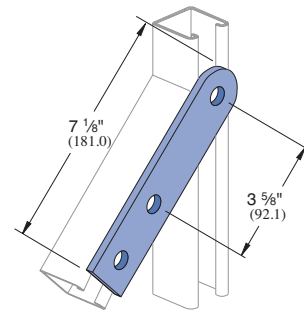

Weight: 75 Lbs/100 Pcs (34.0 kg)

N1026

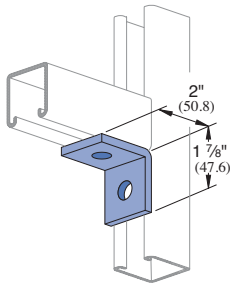

Weight: 38 Lbs/100 Pcs (17.2 kg)

N1068

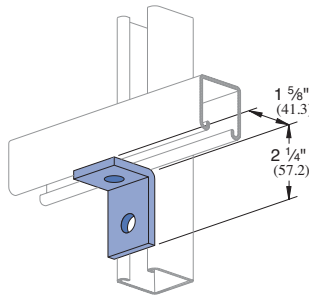

Weight: 38 Lbs/100 Pcs (17.2 kg)

N1325

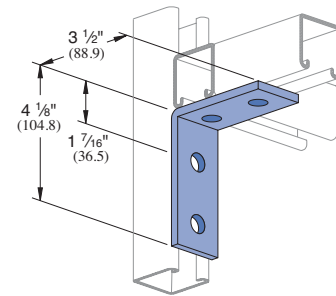

Weight: 78 Lbs/100 Pcs (35.4 kg)

N1326

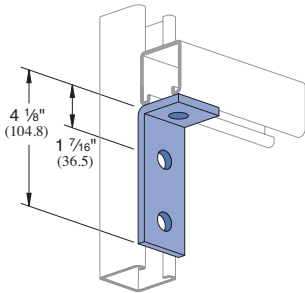

Weight: 58 Lbs/100 Pcs (26.3 kg)

N1346

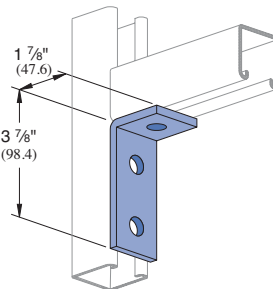

Weight: 58 Lbs/100 Pcs (26.3 kg)

N1359

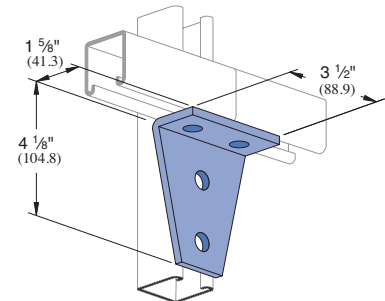

Weight: 105 Lbs/100 Pcs (47.6 kg)

N1382

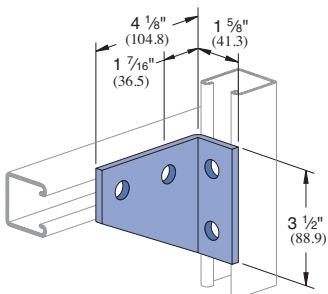

Weight: 105 Lbs/100 Pcs (47.6 kg)

N1458

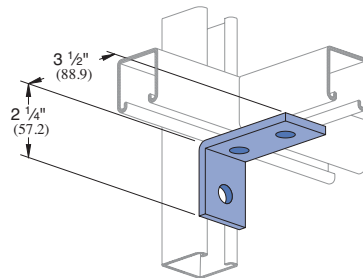

Weight: 58 Lbs/100 Pcs (26.3 kg)

N1750

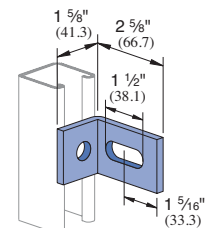

Weight: 38 Lbs/100 Pcs (17.2 kg)

NINETY DEGREE, ANGULAR & "Z" SHAPE FITTINGS

N1956

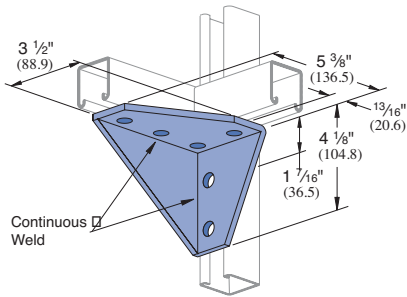

Weight: 230 Lbs/100 Pcs (104.3 kg)

N1957

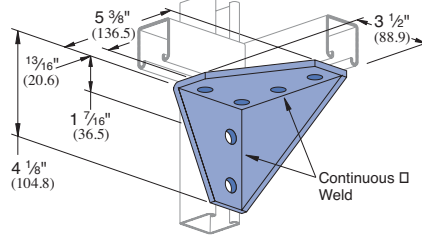

Weight: 230 Lbs/100 Pcs (104.3 kg)

N2235

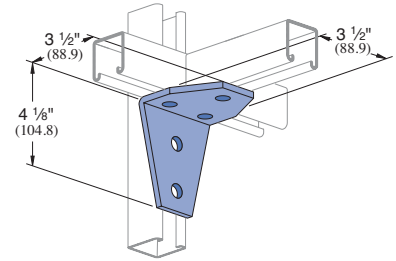

Weight: 135 Lbs/100 Pcs (61.2 kg)

N2484 & N2484 W

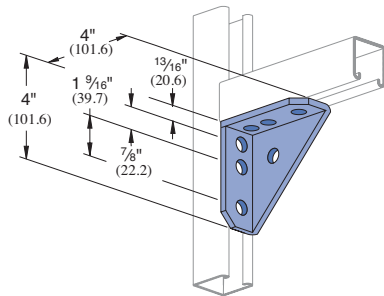

N2484 W same as N2484 except corner welded
Weight: 134 Lbs/100 Pcs (60.8 kg)

N1186, N2105 THRU N2110

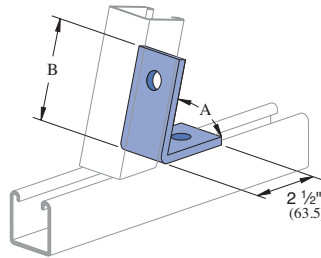

Part Number	Deg.	"A" Rad.	"B" In	"B" mm	Weight/100 pcs.	Lbs	kg
N2105	82½	.46	3 ³ / ₁₆	81.0	58	26.3	
N2106	75	.42	3 ³ / ₁₆	81.0	58	26.3	
N2107	67½	.38	3 ¹ / ₈	79.4	58	26.3	
N2108	60	.33	3 ¹ / ₈	79.4	58	26.3	
N2109	52½	.29	3 ¹ / ₁₆	77.8	58	26.3	
N1186	45	.25	3 ¹ / ₈	79.4	58	26.3	
N2110	37½	.21	3	76.2	58	26.3	

N1546, N2094 THRU N2100

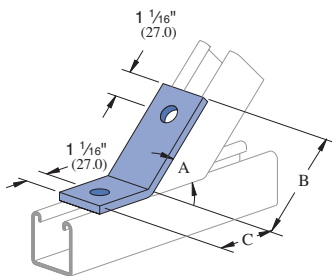

Part Number	Deg.	"A" Rad.	"B" In	"B" mm	"C" In	"C" mm	Weight/100 pcs.	Lbs	kg
N2094	82½	.46	3 ³ / ₁₆	90.5	1 ¹¹ / ₁₆	42.9	58	26.3	
N2095	75	.42	3 ³ / ₁₆	90.5	1 ¹¹ / ₁₆	42.9	58	26.3	
N2096	67½	.38	3 ¹ / ₂	88.9	1 ³ / ₄	44.5	58	26.3	
N2097	60	.33	3 ³ / ₈	85.7	1 ⁷ / ₈	47.6	58	26.3	
N2098	52½	.29	3 ¹ / ₄	82.6	2 ¹ / ₁₆	52.4	58	26.3	
N1546	45	.25	3	76.2	2 ⁵ / ₁₆	58.7	58	26.3	
N2099	37½	.21	3 ¹ / ₂	88.9	1 ¹³ / ₁₆	46.0	58	26.3	
N2100	37½	.21	2 ¹¹ / ₁₆	68.3	2 ⁵ / ₈	66.7	58	26.3	

N1045

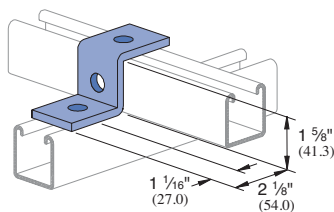

Weight: 55 Lbs/100 Pcs (24.9 kg)

N1347

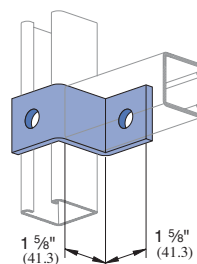

Weight: 55 Lbs/100 Pcs (24.9 kg)

N1453

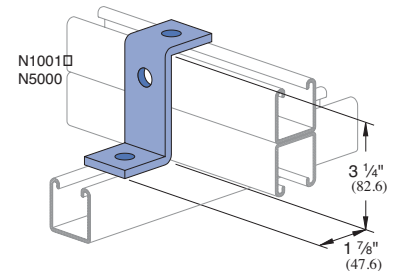

Weight: 70 Lbs/100 Pcs (31.8 kg)



N3045

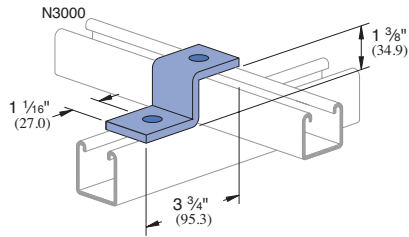

Weight: 53 Lbs/100 Pcs (24.0 kg)

N3345

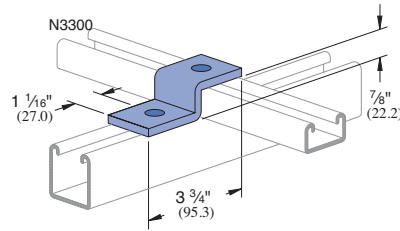

Weight: 47 Lbs/100 Pcs (21.3 kg)

N4045

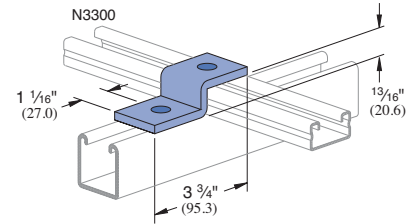

Weight: 47 Lbs/100 Pcs (21.3 kg)

N5545

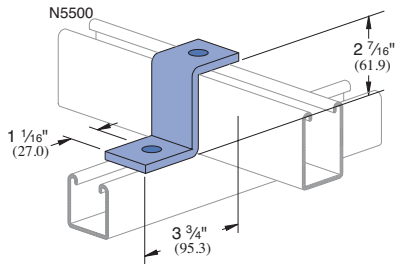

Weight: 67 Lbs/100 Pcs (30.4 kg)

N2469

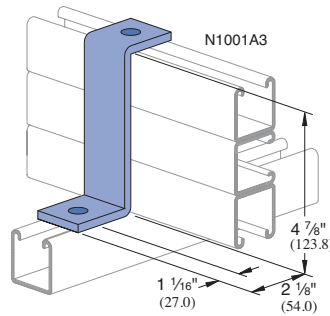

Weight: 93 Lbs/100 Pcs (42.2 kg)

N1047

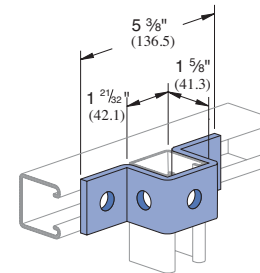

Weight: 88 Lbs/100 Pcs (39.9 kg)

N1048 – N1050

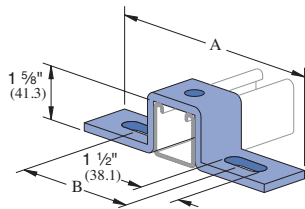

Part Number	"A"		"B"		Weight/100 pcs.	
	In	mm	In	mm	Lbs	kg
N1048	7 1/4	184.2	4 1/8	104.8	105	47.6
N1049	8 1/2	215.9	5 3/8	136.5	120	54.4
N1050	10 3/8	263.5	7 1/4	184.2	130	59.0

N1737

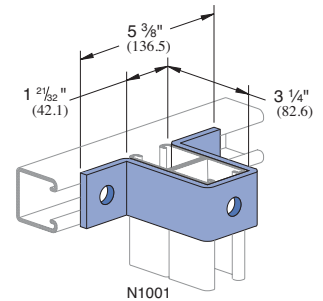

Weight: 128 Lbs/100 Pcs (58.1 kg)

N1376

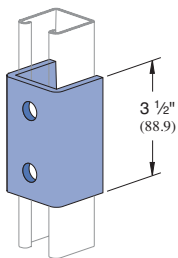

Weight: 128 Lbs/100 Pcs (58.1 kg)

N1376 A

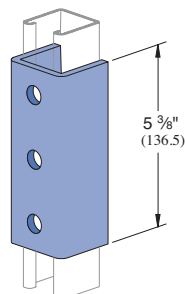

Weight: 197 Lbs/100 Pcs (89.4 kg)

N1377

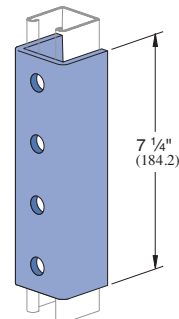

Weight: 265 Lbs/100 Pcs (120.2 kg)

N1383

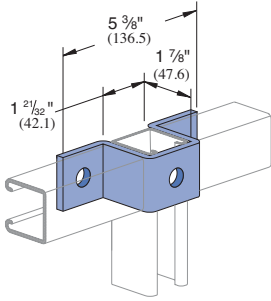

Weight: 95 Lbs/100 Pcs (43.1 kg)

N2326

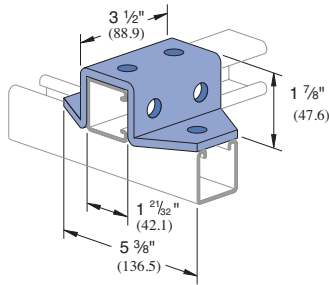

Weight: 171 Lbs/100 Pcs (77.6 kg)

N2473

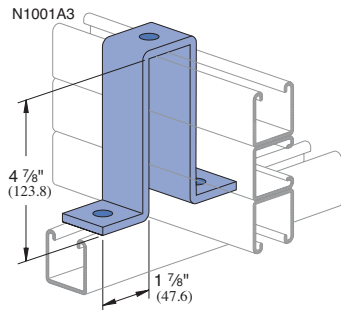

Weight: 197 Lbs/100 Pcs (89.4 kg)

N4376

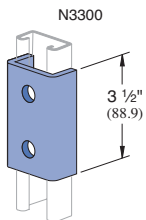

Weight: 85 Lbs/100 Pcs (38.6 kg)

N1834

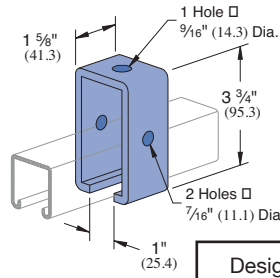

Design Load
1200 Lbs (5.3 kN)

Requires 3/8" x 2-1/2" Bolt & Nut (Not Incl.)

Weight: 102 Lbs/100 Pcs (46.3 kg)

N2328

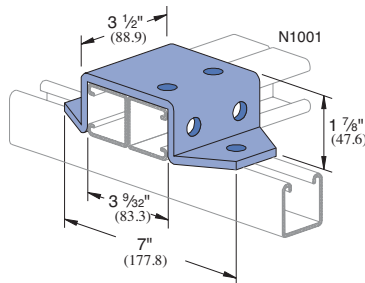

Weight: 209 Lbs/100 Pcs (94.8 kg)

N3047

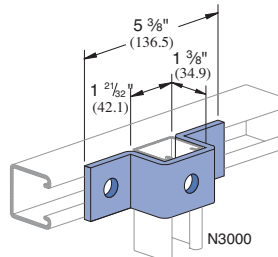

Weight: 84 Lbs/100 Pcs (38.1 kg)

N4376 A

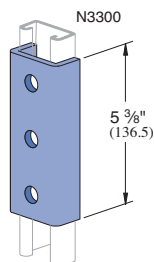

Weight: 130 Lbs/100 Pcs (59.0 kg)

N1834 A

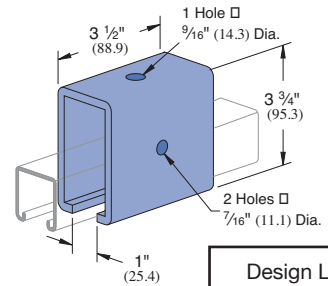

Design Load
2500 Lbs (11.1 kN)

Requires 3/8" x 2-1/2" Bolt & Nut (Not Incl.)

Weight: 220 Lbs/100 (99.8 kg)

N2329

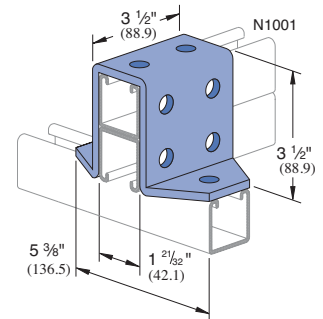

Weight: 257 Lbs/100 (116.6 kg)

N4047

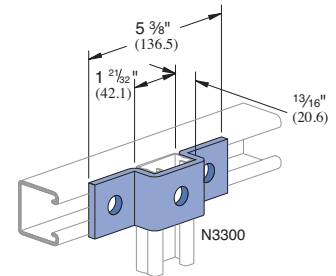

Weight: 71 Lbs/100 Pcs (32.2 kg)

N4377

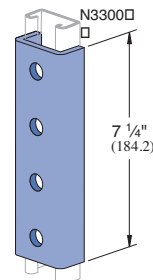

Weight: 176 Lbs/100 Pcs (79.8 kg)



N5543

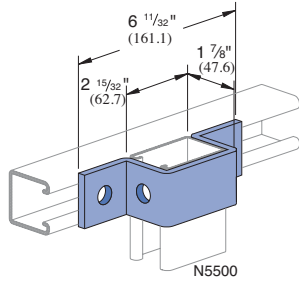

Weight: 97 Lbs/100 Pcs (44.0 kg)

N5547

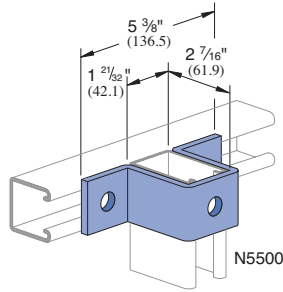

Weight: 108 Lbs/100 Pcs (49.0 kg)

N2223

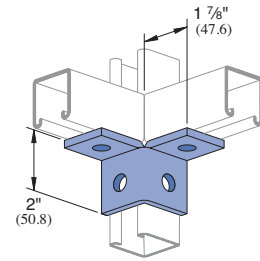

Weight: 76 Lbs/100 Pcs (34.5 kg)

N2224

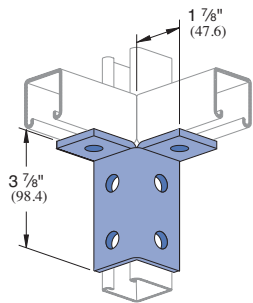

Weight: 115 Lbs/100 Pcs (52.2 kg)

N2225

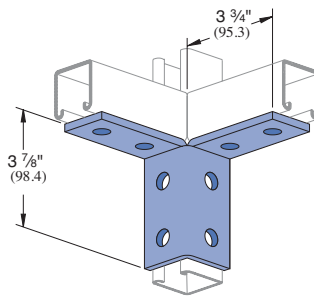

Weight: 155 Lbs/100 Pcs (70.3 kg)

N2227

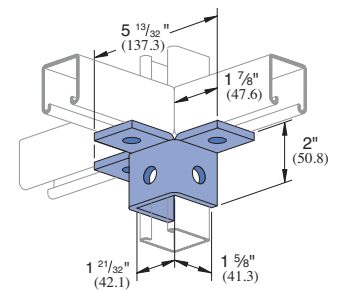

Weight: 113 Lbs/100 Pcs (51.3 kg)

N2228

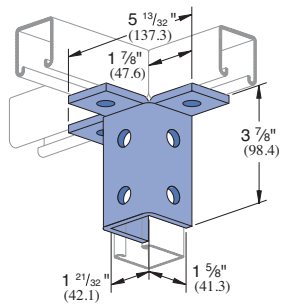

Weight: 177 Lbs/100 Pcs (80.3 kg)

N2229

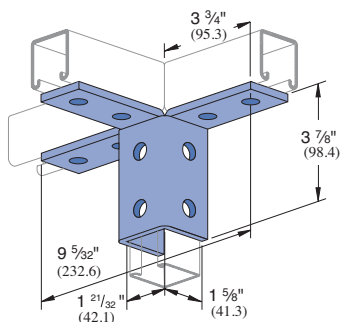

Weight: 230 Lbs/100 Pcs (104.3 kg)

N2343 R-L

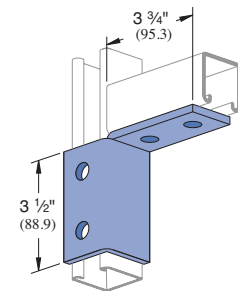

R – As Shown
L – Opposite Hand
Weight: 119 Lbs/100 Pcs (54.0 kg)

N2345

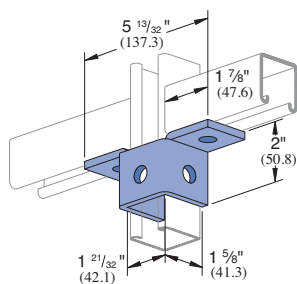

Weight: 93 Lbs/100 Pcs (42.2 kg)

N2346

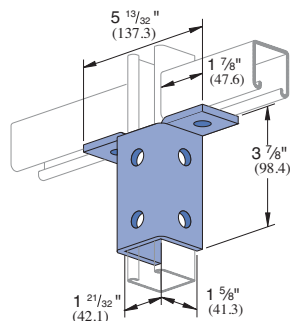

Weight: 150 Lbs/100 Pcs (68.0 kg)

N2347

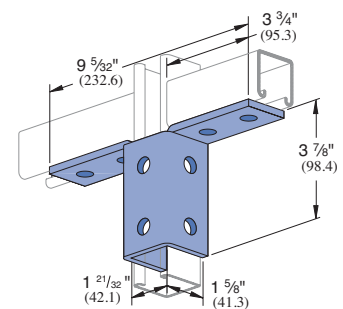

Weight: 193 Lbs/100 Pcs (87.5 kg)

N1280

ONE PIECE END CAP

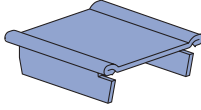

For use with N1000 Channel

Weight: 11 Lbs/100 Pcs (5.0 kg)

N2073 A

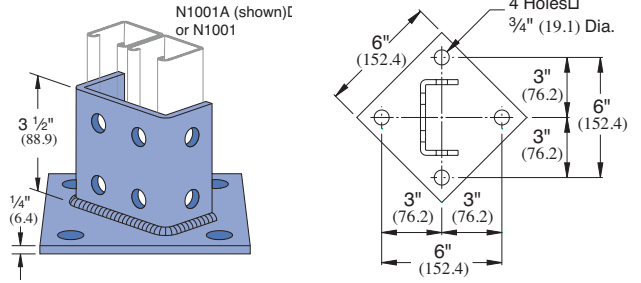

Weight: 408 Lbs/100 Pcs (185.1 kg)

N2072A & N2072A SQ

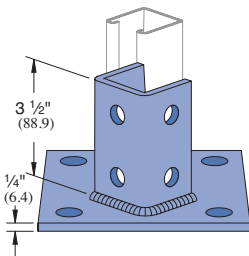

Weight: 373 Lbs/100 Pcs (169.2 kg)

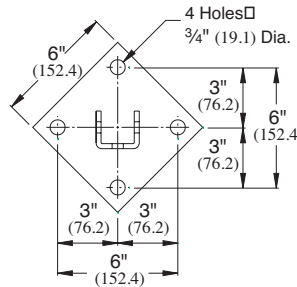

N2072A

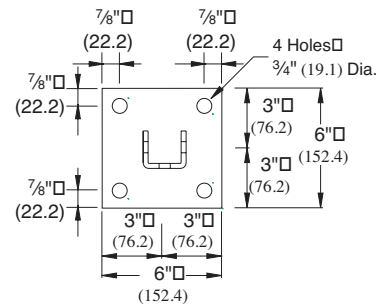

N2072A SQ

N2815 NH

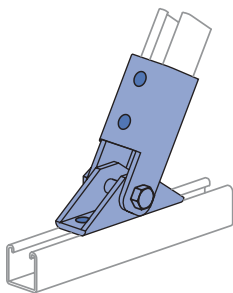

1/2" x 3" Grade 5 bolt, 1/2" nut and 1/2" lock washer not included. Order separately.

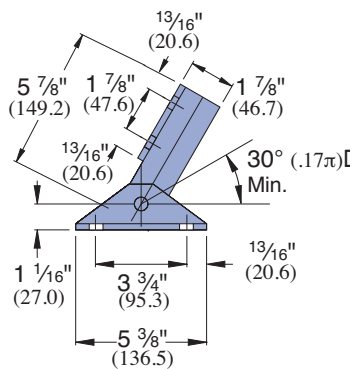

Weight: 307 Lbs/100 Pcs (139.3 kg)

N2815 D NH

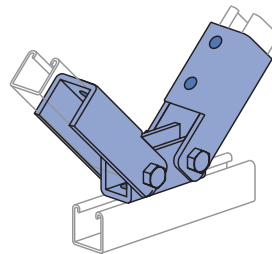

1/2" x 3" Grade 5 bolt, 1/2" nut and 1/2" lock washer not included. Order separately.

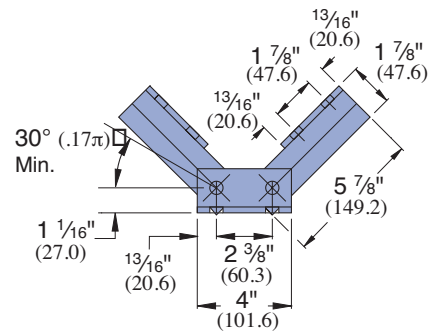

Weight: 497 Lbs/100 Pcs (225.4 kg)



N2944 THRU N2947

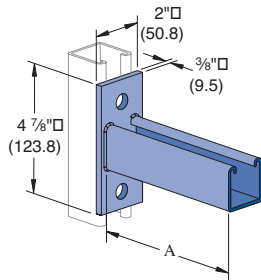

Part Number	"A"		Weight/100 pcs		Uniform Load*	
	In	mm	lbs	Kg	lbs.	kg
P2944	6	152.4	185	83.9	1200	544.3
P2945	12	304.8	293	132.9	600	272.2
P2946	18	457.2	401	181.9	400	181.4
P2947	24	609.6	509	230.9	300	136.1

* Mounted on 12 Ga. Channel
Safety Factor 2½

N2542 THRU N2546

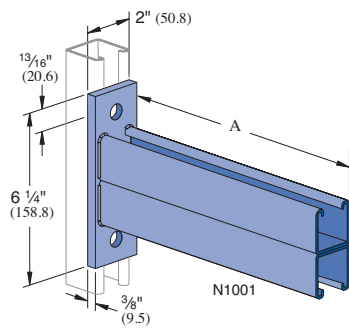

Part Number	"A"		Wt/100 pcs		Vertical Channel		Uniform Load*	
	In	mm	lbs	Kg	Part No.	Gage	lbs.	kg
N2542	12	304.8	502	227.7	N1000	12	2000	8.9
N2543	18	457.2	692	313.9	N1000	12	1300	5.8
N2544	24	609.6	882	400.1	N1000	12	1000	4.4
N2545	30	762.0	1072	486.3	N1000	12	800	3.6
N2546	36	914.4	1262	572.4	N1000	12	650	2.9

Safety Factor 2½

MATERIAL

Unistrut pipe supports, unless noted, are punch-press made from hot-rolled, pickled and oiled steel plates, strip or coil, and conform to ASTM specifications A1011SS, A575, A576, A653, or A36. The fitting steel also meets the physical requirements of ASTM A1011SS GR 33. The pickling of the steel produces a smooth surface free from scale.

Many items are also available in stainless steel. Consult factory for ordering information.

FINISHES

Pipe supports are available in: electro-galvanized (EG), conforming to ASTM B633 Type III SC1; Hot-dipped galvanized (HG), conforming to ASTM A123 or A153.

APPLICATION

Unistrut pipe clamps, pipe hangers, brackets and rollers are designed for the support of electrical and mechanical services. Supports to meet nearly every requirement can be attained using Unistrut Metal Framing components.

DIMENSIONS

Imperial dimensions are illustrated in inches. Metric dimensions are shown in parenthesis or as noted. Unless noted, all metric dimensions are in millimeters and rounded to one decimal place.

DESIGN BOLT TORQUE

Note: When tightening 1/4" screws used with a two piece pipe clamp, a torque of 5 foot pounds (60 inch-

pounds) should be used.

BOLT SIZE	1/4" □	3/8" □	1/2" □	5/8" □	3/4" □
	20	16	13	11	10
FOOT LBS.	6	19	50	100	125
N·m	8	25	70	135	170

DESIGN LOAD

Design load data, where shown, is based on the ultimate strength of the connection with a safety factor of 5.0, unless otherwise noted.

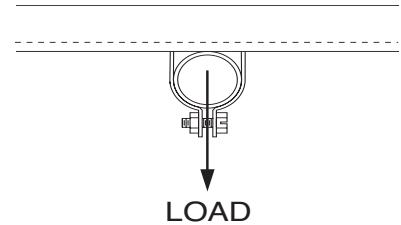

Note: The suffix NH indicates that hardware is not included. Order separately.

N1109 NH THRU N1126 NH

PIPE CLAMPS FOR RIGID STEEL CONDUIT

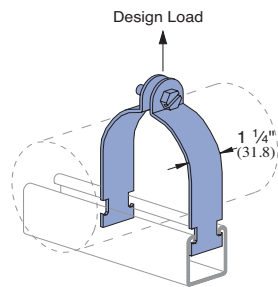

Slotted hex head screw and nut not included.

See chart on page 31 for fasteners.

Finish: Electro-galvanized.(EG)

N1121 NH may also be used with nominal 4" E.M.T.

Part Number	Pipe Size		O.D. Size In	Thickness gauge	Thickness mm	Wt/100 pcs		Design Load	
	In	mm				lbs	Kg	lbs	kN
N1109 NH	3/8	.675	17.1	16	1.5	10	4.5	400	1.8
N1111 NH	1/2	.840	21.3	16	1.5	11	5.0	400	1.8
N1112 NH	3/4	1.050	26.7	14	1.9	15	6.8	600	2.7
N1113 NH	1	1.315	33.4	14	1.9	17	7.7	600	2.7
N1114 NH	1 1/4	1.660	42.2	14	1.9	19	8.6	600	2.7
N1115 NH	1 1/2	1.900	48.3	12	2.7	29	13.2	800	3.6
N1117 NH	2	2.375	60.3	12	2.7	34	15.4	800	3.6
N1118 NH	2 1/2	2.875	73.0	12	2.7	40	18.1	800	3.6
N1119 NH	3	3.500	88.9	12	2.7	47	21.3	800	3.6
N1120 NH	3 1/2	4.000	101.6	11	3.0	62	28.1	1000	4.4
N1121 NH	4	4.500	114.3	11	3.0	67	30.4	1000	4.4
N1123 NH	5	5.563	141.3	11	3.0	80	36.3	1000	4.4
N1124 NH	6	6.625	168.3	10	3.4	102	46.3	1000	4.4
N1126 NH	8	8.625	219.1	10	3.4	130	59.0	1000	4.4

N1211 NH THRU N1217 NH

UNIVERSAL CLAMPS FOR RIGID OR THINWALL CONDUIT

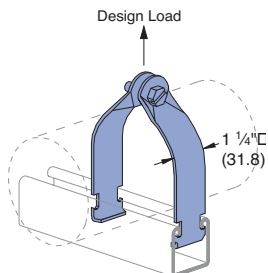

Slotted hex head screw and nut not included.

See chart on page 31 for fasteners.

Finish: Electro-galvanized.(EG)

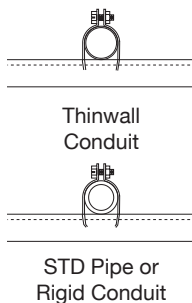

Part Number	Pipe/Conduit Size		Thickness gauge	Thickness mm	Wt/100 pcs		Design Load	
	In	mm			lbs	Kg	lbs	kN
N1211 NH	1/2	16	1.5	10	4.5	400	1.8	
N1212 NH	3/4	16	1.5	11	5.0	400	1.8	
N1213 NH	1	16	1.5	12	5.4	400	1.8	
N1214 NH	1 1/4	14	1.9	18	8.2	600	2.7	
N1215 NH	1 1/2	14	1.9	20	9.1	600	2.7	
N1217 NH	2	14	1.9	22	10.0	600	2.7	



N1425 NH THRU N1431 NH

PIPE CLAMPS FOR THIN WALL CONDUIT (E.M.T.)

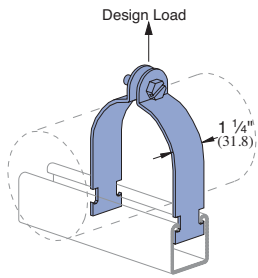

Slotted hex head screw and nut not included.

See chart on page 31 for fasteners.

Finish: Electro-galvanized.(EG)

Part Number	Pipe Size		O.D. Size		Thickness		Wt/100 pcs		Design Load	
	In	mm	In	mm	gauge	mm	lbs	Kg	lbs	kN
N1425 NH	3/8	9.5	0.577	14.7	16	1.5	9	4.1	400	1.8
N1426 NH	1/2	12.7	0.706	17.9	16	1.5	11	5.0	400	1.8
N1427 NH	3/4	19.1	0.922	23.4	16	1.5	12	5.4	400	1.8
N1428 NH	1	25.4	1.163	29.5	14	1.9	15	6.8	600	2.7
N1429 NH	1 1/4	31.8	1.510	38.4	14	1.9	18	8.2	600	2.7
N1430 NH	1 1/2	38.1	1.740	44.2	12	2.7	29	13.2	800	3.6
N1431 NH	2	50.8	2.197	55.8	12	2.7	33	15.0	800	3.6
N1118 NH	2 1/2	63.5	2.875	73.0	12	2.7	40	18.1	800	3.6
N1119 NH	3	76.2	3.500	88.9	12	2.7	47	21.3	800	3.6
N1120 NH	3 1/2	89.0	4.000	101.6	11	3.0	62	28.1	1000	4.4
N1121 NH	4	101.6	4.500	114.3	11	3.0	67	30.4	1000	4.4

N2024 NH THRU N2070-84 NH

PIPE CLAMPS FOR O.D. TUBING

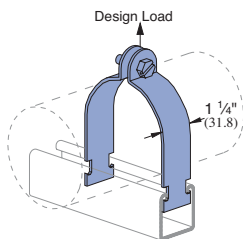

Slotted hex head screw and nut not included.

See chart on page 31 for fasteners.

Finish: Electro-galvanized.(EG)

- N2024 - N2029 16 ga.
- N2030 - N2035 14 ga.
- N2037 - N2044 12 ga.
- N2059 - N2066 11 ga.
- N2067 - N2070-84 10 ga.

Part Number	Pipe O.D. Size		Wt/100 Pcs.		Design Load lbs(Kn)
	In	mm	lbs	Kg	
N2024 NH	1/4	6.4	8	3.6	
N2025 NH	3/8	9.5	8	3.6	
N2026 NH	1/2	12.7	9	4.1	400
N2027 NH	5/8	15.9	10	4.5	(1.8)
N2028 NH	3/4	19.1	11	5.0	
N2029 NH	7/8	22.2	12	5.4	
N2030 NH	1	25.4	14	6.4	
N2031 NH	1 1/8	28.6	15	6.8	
N2032 NH	1 1/4	31.8	16	7.3	600
N2033 NH	1 3/8	34.9	17	7.7	(2.7)
N2034 NH	1 1/2	38.1	18	8.2	
N2035 NH	1 5/8	41.3	19	8.6	
N1430 NH	1 3/4	44.5	29	13.2	
N2037 NH	1 7/8	47.6	28	12.7	
N2038 NH	2	50.8	31	14.1	
N2039 NH	2 1/8	54.0	32	14.5	
N2040 NH	2 1/4	57.2	33	15.0	800
N1117 NH	2 3/8	60.3	34	15.4	(3.6)
N2042 NH	2 1/2	63.5	35	15.9	
N2043 NH	2 5/8	66.7	37	16.8	
N2044 NH	2 3/4	69.9	38	17.2	
N1118 NH	2 7/8	73.0	40	18.1	
N1121 NH	4 1/2	114.3	67	30.4	
N2059 NH	4 5/8	117.5	70	31.8	
N2060 NH	4 3/4	120.7	72	32.7	1000
N2061 NH	4 7/8	123.8	73	33.1	(4.4)
N2062 NH	5	127.0	74	33.6	
N2063 NH	5 1/8	130.2	76	34.5	

Part Number	O.D. Size		Pcs.		Load lbs(Kn)
	In	mm	lbs	Kg	
N2064 NH	5 1/4	133.4	77	34.9	
N2065 NH	5 3/8	136.5	78	35.4	
N2066 NH	5 1/2	139.7	79	35.8	
N2067 NH	5 5/8	142.9	88	39.9	
N2068 NH	5 3/4	146.1	90	40.8	
N2069 NH	5 7/8	149.2	92	41.7	
N2070 NH	6	152.4	94	42.6	
N2070-61 NH	6 1/8	155.6	96	43.5	
N2070-62 NH	6 1/4	158.8	98	44.5	
N2070-63 NH	6 3/8	161.9	99	44.9	
N2070-64 NH	6 1/2	165.1	100	45.	
N1124 NH	6 5/8	168.3	102	46.3	1000
N2070-66 NH	6 3/4	171.5	104	47.2	(4.4)
N2070-67 NH	6 7/8	174.6	106	48.1	
N2070-70 NH	7	177.8	108	49.0	
N2070-71 NH	7 1/8	181.0	110	49.9	
N2070-72 NH	7 1/4	184.2	112	50.8	
N2070-73 NH	7 3/8	187.3	114	51.7	
N2070-74 NH	7 1/2	190.5	116	52.6	
N2070-75 NH	7 5/8	193.7	117	53.1	
N2070-76 NH	7 3/4	196.9	119	54.0	
N2070-77 NH	7 7/8	200.0	121	54.9	
N2070-80 NH	8	203.2	123	55.8	
N2070-81 NH	8 1/8	206.4	125	56.7	
N2070-82 NH	8 1/4	209.6	126	57.2	
N2070-83 NH	8 3/8	212.7	128	58.1	
N2070-84 NH	8 1/2	215.9	129	58.5	
N1126 NH	8 5/8	219.1	130	59.0	

FASTENERS FOR UNISTRUT PIPE CLAMPS

See pages 29 - 30

O.D. Tube Size Pipe Clamp Series	Hex Slotted Machine Screw Part No.	Size (In.)	Hex Nut Part No.	Size(In.)
N1109 NH - N1114 NH	NSHS025075EG	1/4" x 3/4"	NHXN025EG	1/4"
N1115 NH - N1117 NH	NSHS031100EG	5/16" x 1"	NHXN031EG	5/16"
N1118 NH - N1119 NH	NSHS031100EG	5/16" x 1"	NHXN031EG	5/16"
N1120 NH - N1126 NH	NSHS037125EG	3/8" x 1-1/4"	NHXN037EG	3/8"
N1211 NH	NSHS025100EG	1/4" x 1"	NHXN025EG	1/4"
N1212 NH - N1213 NH	NSHS025125EG	1/4" x 1-1/4"	NHXN025EG	1/4"
N1214 NH - N1217 NH	NSHS031137EG	5/16" x 1-3/8"	NHXN031EG	5/16"
N1425 NH - N1429 NH	NSHS025075EG	1/4" x 3/4"	NHXN025EG	1/4"
N1430 NH - N1431 NH	NSHS031100EG	5/16" x 1"	NHXN031EG	5/16"
N3409 NH - N3413 NH	NSHS031100EG	5/16" x 1"	NHXN031EG	5/16"
N3414 NH	NSHS031125EG	5/16" x 1-1/4"	NHXN031EG	5/16"
N3515 NH - N3417 NH	NSHS031175EG	5/16" x 1-3/4"	NHXN031EG	5/16"
N2024 NH - N2030 NH	NSHS025075EG	1/4" x 3/4"	NHXN025EG	1/4"
N2031 NH - N2035 NH	NSHS025100EG	1/4" x 1"	NHXN025EG	1/4"
N2037 NH - N2049 NH	NSHS031100EG	5/16" x 1"	NHXN031EG	5/16"
N2051 NH - N2070-84 NH	NSHS037125EG	3/8" x 1-1/4"	NHXN037EG	3/8"

N2008 THRU N2020

ONE HOLE CLAMP FOR O.D. TUBING

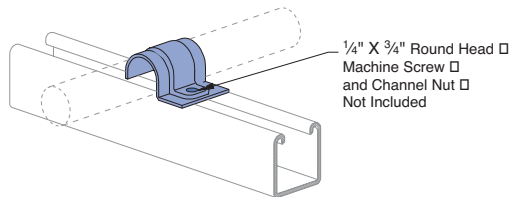

Hardware sold separately.

See pages 18 - 19, for screws & channel nuts

Finish: Electro-galvanized.(EG)

Order NSHS025075EG Separately

Part Number	O.D. Tube Size		Thickness gauge	Wt/100 pcs		
	In	mm		lbs	Kg	
N2008	1/4	6.4	16	1.5	4	1.8
N2009	5/16	7.9	16	1.5	5	2.3
N2010	3/8	9.5	16	1.5	5	2.3
N2012	1/2	12.7	16	1.5	6	2.7
N2014	5/8	15.9	14	1.9	8	3.6
N2016	3/4	19.1	14	1.9	9	4.1
N2018	7/8	22.2	14	1.9	10	4.5
N2020	1	25.4	14	1.9	11	5.0

N2558-05 THRU N2558-60

SINGLE PIECE PIPE STRAP

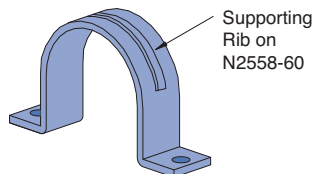
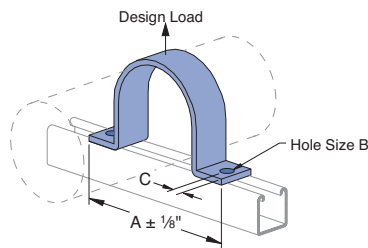

Hardware sold separately.

See pages 18 - 19, for screws & channel nuts

Part Number	Nominal Pipe Size			"B"	"C"	Thickness	Weight/C		Design Load
	In	"A"	mm				Lbs	kg	
N2558-05	1/2	2 7/8	73.0				23	10.4	
N2558-07	3/4	3 3/8	79.4				26	11.8	
N2558-10	1	3 3/8	85.7	9/32	7.1	7/16	11.1	1/8 (3.2)	500 (2.2)
N2558-12	1 1/4	3 3/4	95.3				35	15.9	
N2558-15	1 1/2	3 7/8	98.4				39	17.7	
N2558-20	2	5 3/4	146.1				94	42.6	
N2558-25	2 1/2	6 1/4	158.8				114	51.7	
N2558-30	3	6 7/8	174.6				133	60.3	
N2558-35	3 1/2	7 3/8	187.3	7/16	11.1	1 1/16	17.5	1/4 (6.4)	1000 (4.4)
N2558-40	4	7 7/8	200.0				176	79.8	
N2558-50	5	9	228.6				198	89.8	
N2558-60	6	10	254.0				225	102.1	



Note: The suffix NH indicates that hardware is not included. Order separately.

N2675 NH

Light Duty

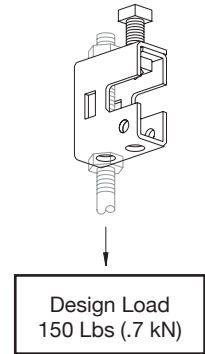
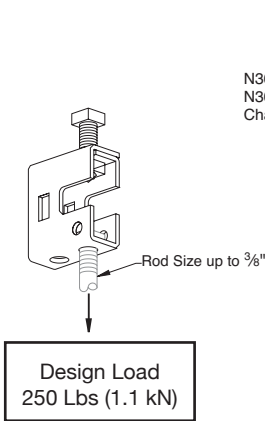
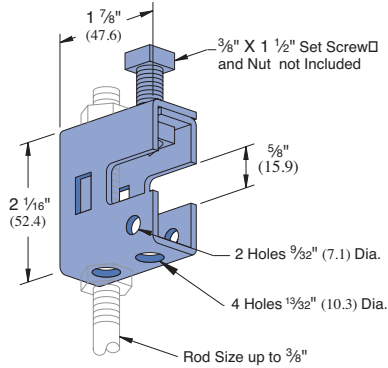

Wt/C 33 Lbs (15.0 kg)

Clamp N2675 is designed for light duty rod suspension. It also may be used with N3016-1024 or N3016-1420 nut as illustrated above for mounting insulators, etc.

Clamp Materials: .105" (2.7) thick steel.

N2676 NH

Medium Duty

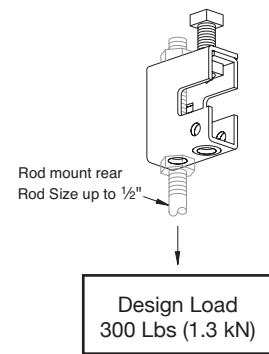
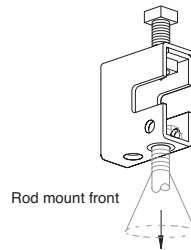
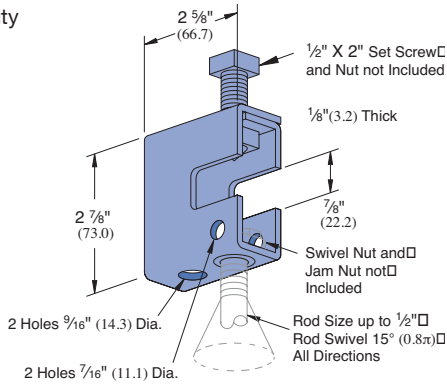

Wt/C 72 Lbs (32.7 kg)

Clamp N2676 provides a means of rod suspension where a free swing of up to 15° (0.8π) is required. Clamp will accommodate 1/4" (6.4), 3/8" (9.5), or 1/2" (12.7) rods. Order swivel nuts N2679-4, -6, or -8 as required. Clamp may also be used with N2677 as illustrated in application drawings on the following page.

Clamp Materials: 1/8" (3.2) thick steel.

N1271 NH

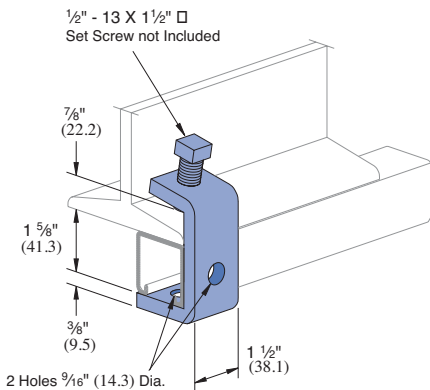

Design Load Each
500 Lbs (2.2 kN)
Use in Pairs Only

Wt/C 95 Lbs (43.1 kg)

N1796 NH

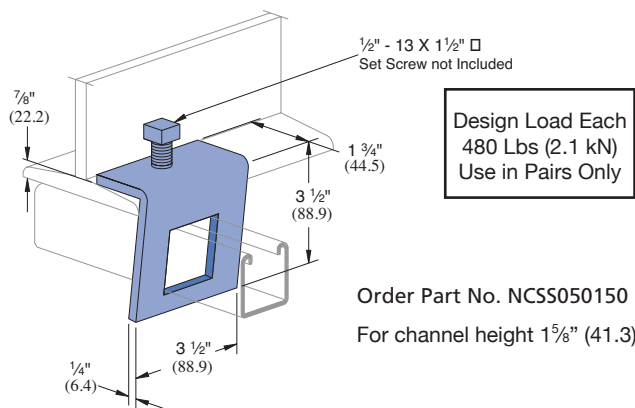

Design Load Each
480 Lbs (2.1 kN)
Use in Pairs Only

Order Part No. NCSS050150
For channel height 1 5/8" (41.3).

Wt/C 91 Lbs (41.3 kg)

BEAM CLAMPS

Note: The suffix NH indicates that hardware is not included. Order separately.

N1648 NH – N1653 NH

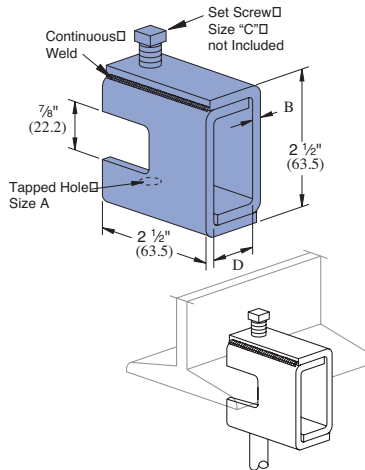

Part Number	"A"		"B"		"C"		"D"		Weight/C		Design Load	
	In	mm	In	mm	In	mm	In	mm	Lbs	kg	Lbs	kN
N1648 NH	1/4 - 20	3.2	1/8	3.2	3/8 x 1 1/2	7/8	22.2	67	30.4	650	2.9	
N1649 NH	5/16 - 18	3.2	1/8	3.2	3/8 x 1 1/2	7/8	22.2	67	30.4	650	2.9	
N1649 A NH	3/8 - 16	3.2	1/8	3.2	3/8 x 1 1/2	7/8	22.2	67	30.4	650	2.9	
N1650 NH	3/8 - 16	4.8	3/16	4.8	1/2 x 1 1/2	15/16	23.8	100	45.4	1100	4.9	
N1650 A NH	1/2 - 13	4.8	3/16	4.8	1/2 x 1 1/2	15/16	23.8	100	45.4	1100	4.9	
N1651 NH	1/2 - 13	6.4	1/4	6.4	1/2 x 1 1/2	15/16	23.8	130	59.0	1600	7.1	
N1651 A NH	5/8 - 11	6.4	1/4	6.4	1/2 x 1 1/2	15/16	23.8	130	59.0	1600	7.1	
N1652 NH	5/8 - 11	7.9	5/16	7.9	5/8 x 1 1/2	1 1/16	33.3	160	72.6	2400	10.7	
N1653 NH	3/4 - 10	7.9	5/16	7.9	5/8 x 1 1/2	1 1/16	33.3	160	72.6	2400	10.7	

For beams under 7/8" (22.2) thick flange.

N2398 NH, N2401 NH & N2403 NH

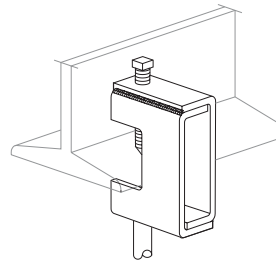
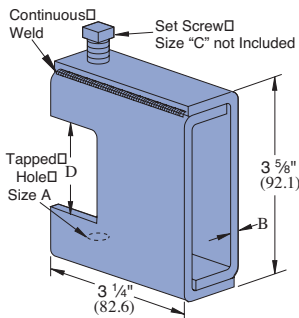

For beams between 3/4" (19.1) to 1 1/8" (41.3) thick flanges.

Part Number	"A"		"B"		"C"		"D"		Weight/C		Design Load	
	In	mm	In	mm	In	mm	In	mm	Lbs	kg	Lbs	kN
N2398 NH	1/4 - 20	3.2	1/8	3.2	3/8 x 2	1 21/32	42.1	109	49.4	800	3.6	
N2401 NH	3/8 - 16	4.8	3/16	4.8	1/2 x 2	1 11/16	42.9	156	70.8	1300	5.8	
N2403 NH	1/2 - 13	6.4	1/4	6.4	1/2 x 2	1 11/16	42.9	201	91.2	1900	8.5	

N1386

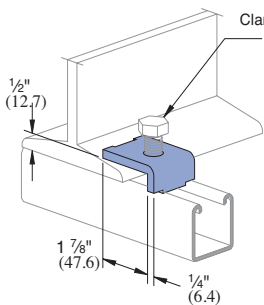

Clamp Requires
1/2" - 13 X 1 1/2" Hex Head Cap Screw (NHCS050150) and 1/2" Channel Nut Not Included.

Design Load Each
600 Lbs (2.7 kN)
Use in Pairs Only

Cap Screw NHCS050150
For use with Channel N1000

Wt/100 pcs 27 Lbs (12.2 kg)

N1379 NH

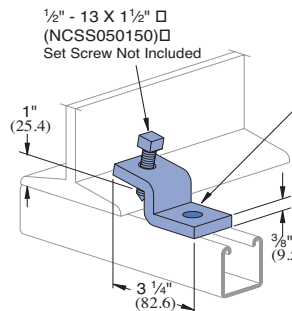

Design Load Each
600 Lbs (2.7 kN)
Use in Pairs Only

Clamp Requires
1/2" x 1 1/16" Hex Head Cap Screw and 1/2" Channel Nut Not Included.

Cap Screw NHCS050150
For use with Channel N1000

Wt/100 pcs 75 Lbs (34.0 kg)

N1272 NH & N1985 NH & N1986 NH

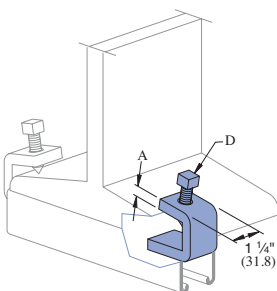

1/2" - 13 x 1 1/2" set screw not included.

Order fasteners separately. Use in pairs.

Part Number	"A"		Flange Thickness		Set Screw (not included)	Weight/C		Design Load (Use in Pairs Only)	
	In	mm	In	mm		Lbs	kg	Lbs	kN
N1272 NH	1/4	6.4	Up to 3/4	Up to 19.1	NCSS037150	39	17.7	450	2.0
N1985 NH	3/8	9.5	Up to 3/4	Up to 19.1	NCSS050150	62	28.1	1000	4.4
N1986 NH	3/8	9.5	7/8 to 2	22.2 to 50.8	NCSS050150	74	33.6	900	4.0



N3270 CONTINUOUS INSERT

Unistrut N3270 continuous insert is designed to be used in ceilings, walls, or floors. All nuts designed for N3000 (see page 18 - 19) will fit the N3270 insert. Unistrut nuts can be inserted anywhere along the length of the insert providing a means of attaching fittings or rods. The N3270 insert is available in pre-galvanized (PG) or hot-dipped galvanized (HG) finishes.

Nail holes are knockouts to prevent concrete seepage. Anchors on 4" centers.

N3280 end cap used when end distance to first anchor is up to 2".
N3704 end cap anchor is used when end distance to first anchor is over 2".

Recommended concrete inserts be nailed or anchored to forms every 16 to 24 inches.

Optional closure (I.E. P3712 P) (commercial grade) available to inhibit concrete seepage.

LOAD DATA

Recommended loading on the N3270 insert in average good concrete: N3270 – 2000 lbs. in each foot of length.
Minimum safety factor 3.

Concentrated load on the end two inches of the insert should be not more than 1000 pounds. Sufficient concrete must surround the insert to conform to design shear stress. The distance between the insert centerline and the concrete edge must be a minimum of 3".

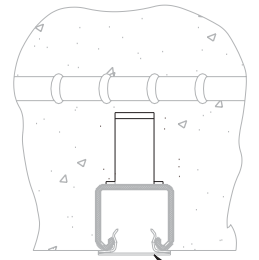
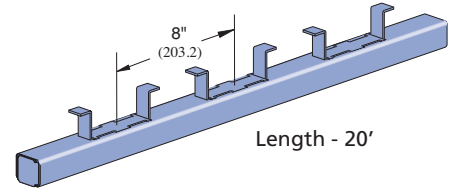

P3712 P
(Commercial Grade)

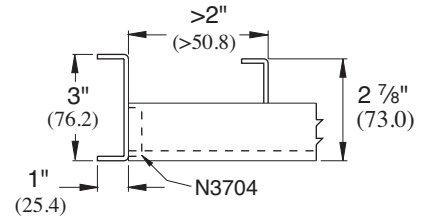
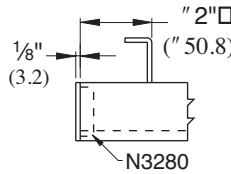
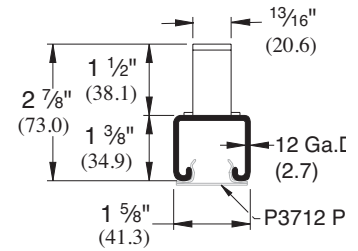

Weight: 3882 Lbs/100 Ft (1760.8 kg)

N3370 CONTINUOUS INSERT

Unistrut N3370 continuous insert is designed to be used in ceilings, walls, or floors. All nuts designed for N3300 (see page 18 - 19) will fit the N3370 insert. Unistrut nuts can be inserted anywhere along the length of the insert providing a means of attaching fittings or rods. The N3370 insert is available in pre-galvanized (PG) or hot-dipped galvanized (HG) finishes.

Nail holes are knockouts to prevent concrete seepage. Anchors on 4" centers.

N3380 end cap used when end distance to first anchor is up to 2".
N3703 end cap anchor is used when end distance to first anchor is over 2".

Recommended concrete inserts be nailed or anchored to forms every 16 to 24 inches.

Optional closure (I.E. P3712 P) (commercial grade) available to inhibit concrete seepage.

LOAD DATA

Recommended loading on the N3370 insert in average good concrete: N3370 – 1500 lbs. in each foot of length.
Minimum safety factor 3.

Concentrated load on the end two inches of the insert should be not more than 750 pounds. Sufficient concrete must surround the insert to conform to design shear stress. The distance between the insert centerline and the concrete edge must be a minimum of 3".

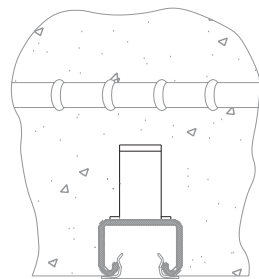
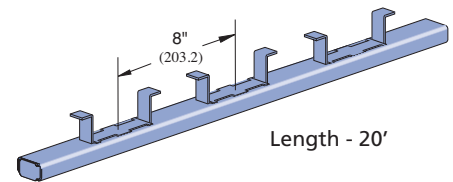

P3712 P
(Commercial Grade)

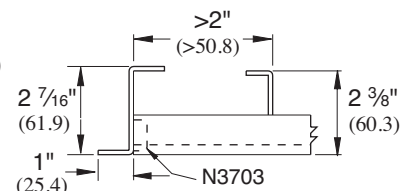
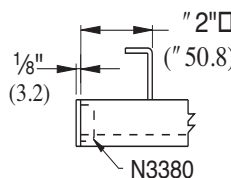
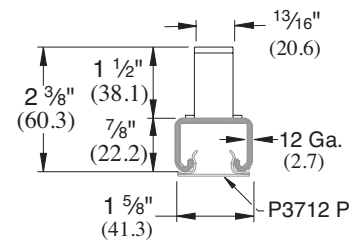

Weight: 2775 Lbs/100 Ft (1258.7 kg)

CONCRETE INSERTS

N1703, N1704 & N3704 END CAP ANCHORS

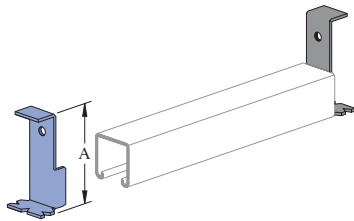

End cap anchors are designed for use with short pieces of Unistrut Channel to form concrete inserts.

Material: 12 Gage.

Part Number	Channel	"A"		Wt./100 pcs.	
		In	mm	Lbs	kg
N1703	N1000	2 ¹³ / ₃₂	61.1	30	13.6
N1704	N1000	3 ¹⁷ / ₃₂	89.7	37	16.8
N3704	N3000	3	76.2	20	9.1

N3703 END CAP ANCHORS

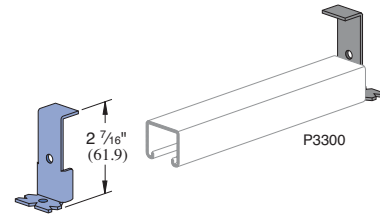

Material: 12 Gage.

Wt/C 17 Lbs (7.7 kg)

N2407, N3280 & N3380 SINGLE PIECE END CAPS

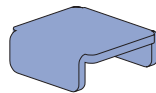

Material: 14 Gage.

Part Number	Channel	Wt./100 pcs.	
		Lbs	kg
N2407	N1000	10	4.5
N3280	N3000	8	3.6
N3380	N3300	5	2.3

N3663, N4663 JOINT COVERS

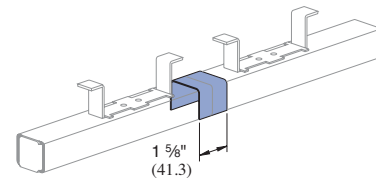

- The N3663 & N4663 cover plate is designed to cover the joint between the inserts when they are butted end to end.
- Material: 16 Gage.

Part Number	Channel	Wt./100 pcs.	
		Lbs	kg
N3663	N3270	10	4.5
N4663	N3370	6	2.7



CANTILEVER BEAMS

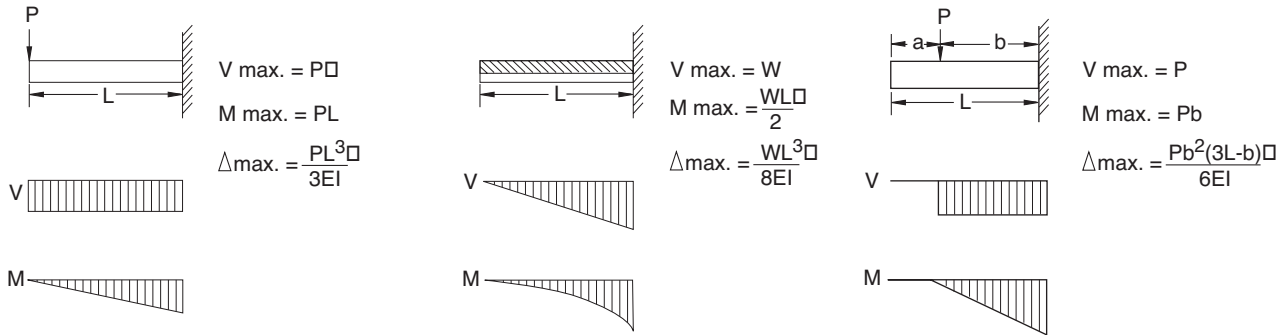

SIMPLE BEAMS

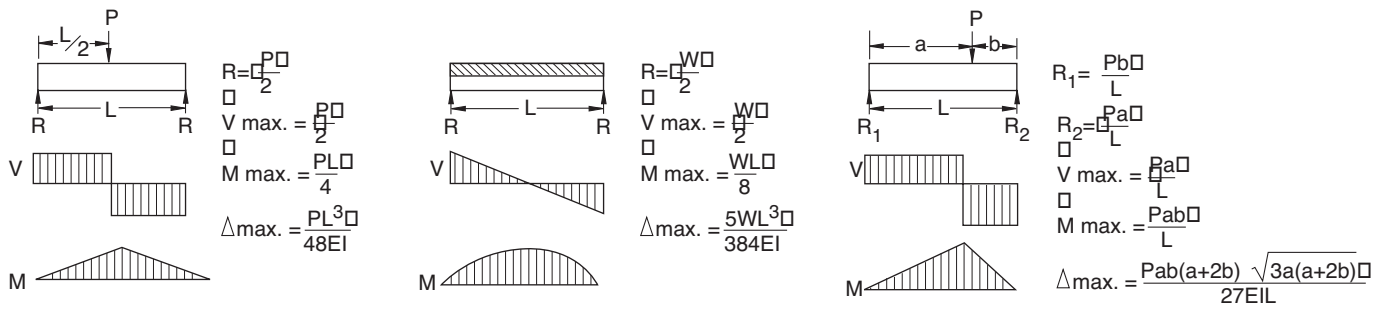

BEAMS FIXED AT ONE END, SUPPORTED AT OTHER

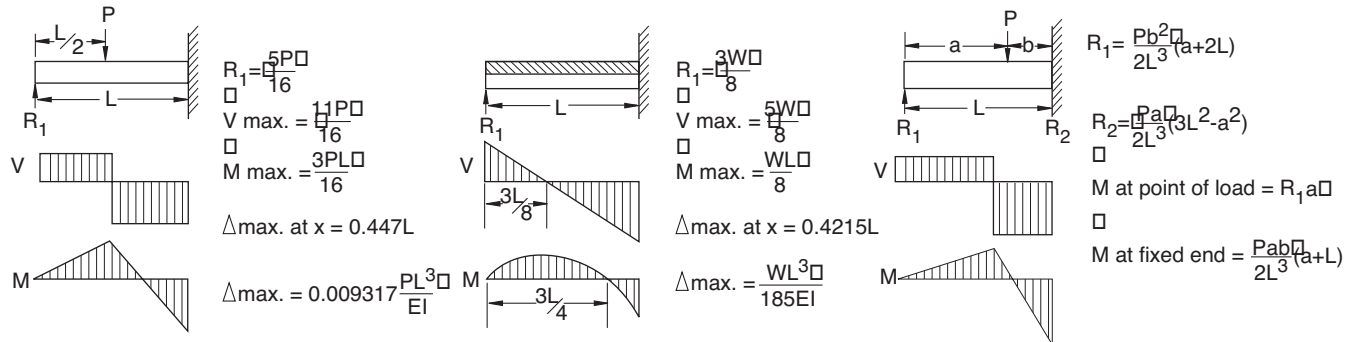

BEAMS FIXED AT BOTH ENDS

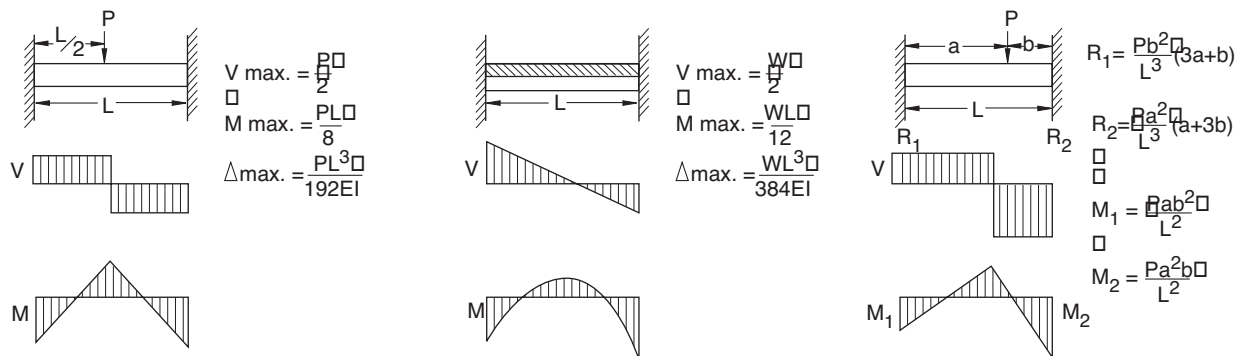

R – Reaction
M – Moment
P – Concentrated Load







W – Total Uniform Load
V – Shear
L – Length

Δ – Deflection
E – Modulus of Elasticity
I – Moment of Inertia

CONVERSION FACTORS FOR BEAMS WITH VARIOUS STATIC LOADING CONDITIONS

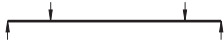
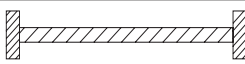
All Beam Load tables are for single-span (simple) beams supported at the ends. These can be used in the majority of the cases.

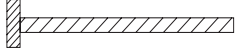
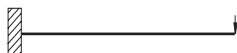
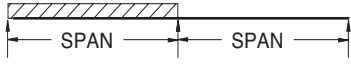
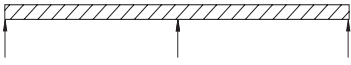
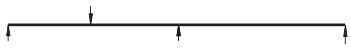
There are times when it is necessary to know what happens with other loading and support conditions. Some common arrangements are shown below. Simply multiply the values from the Beam Load tables by factors given below

LOAD AND SUPPORT CONDITION	LOAD FACTOR	DEFLECTION FACTOR
1. Simple Beam, □ Uniform Load 	□ 1.00	□ 1.00
2. Simple Beam, □ Concentrated Load at Center 	□ .50	□ .80
3. Simple Beam, □ Two Equal Concentrated Loads at 1/4 pts 	□ 1.00	□ 1.10
4. Beam Fixed at Both Ends, □ Uniform Load 	□ 1.50	□ .30
5. Beam Fixed at Both Ends, □ Concentrated Load at Center 	□ 1.00	□ .40
6. Cantilever Beam, □ Uniform Load 	□ .25	□ 2.40
7. Cantilever Beam, □ Concentrated Load at End 	□ .12	□ 3.20
8. Continuous Beam, Two Equal Spans, □ Uniform Load on One Span 	□ 1.30	□ .92
9. Continuous Beam, Two Equal Spans, □ Uniform Load on Both Ends 	□ 1.00	□ .42
10. Continuous Beam, Two Equal Spans, □ Concentrated Load at Center of One Span 	□ .62	□ .71
11. Continuous Beam, Two Equal Spans, □ Concentrated Load at Center of Each Span 	□ .67	□ .48

EXAMPLE I

PROBLEM:

Determine load and deflection of a N1000 beam continuous over one support and loaded uniformly on one span.

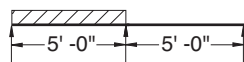

SOLUTION:

- A. From load table for N1000 on page 24 load for a 5'-0" span is 680# and deflection is .35".
- B. Multiply by factors from Table above.
Load = 680# x 1.30 = 884#
Deflection = .35" x .92 = .32"

EXAMPLE II

PROBLEM:

Determine load and deflection of a N5500 cantilever beam with a concentrated load on the end.



SOLUTION:

- A. From load table N5500 on page 57 load for a 3'-0" span is 2190# and deflection is .09".
- B. Multiply by factors from Table above.
Load = 2190# x .12 = 263#
Deflection = .09" x 3.20 = .29"



COLUMN LENGTH

The column length is measured from braced point to braced point. A braced point is where the column is restrained from lateral movement (translation) in all directions.

TYPES OF LOADING

a) Concentric Loading

Loads applied to the center of gravity of the column cross-section are considered concentric. A beam that passes over and rests on the top of a column is an example of concentric loading.

b) Eccentric Loading

Any load which is not concentric is eccentric. The amount of eccentricity (in inches) has a major effect on the load-carrying capacity of any particular column. A load that is transmitted to a Unistrut Metal Framing column using a standard fitting bolted to the slot face is considered eccentric.

The load tables give allowable loads for both concentric (loaded at C.G.) and certain eccentric (loaded at slot face) loading. Allowable loads for other eccentric loading must be determined by a qualified design professional.

SUPPORT CONDITIONS

Based on the support conditions, an appropriate "K" value is selected. This "K" value, which mathematically describes the column end conditions, is used in the column design equations. The most common support condition combinations are as follows:

a) Fixed Top – Fixed Bottom



Both ends are restrained against rotation and lateral movement (translation). K equals .65.

b) Pinned Top – Fixed Bottom



The top is restrained against lateral movement (translation) but, is allowed to rotate. The bottom is restrained against rotation and lateral movement. This is a common support condition and is used to construct the allowable column load applied at the Slot Face tables. "K" equals .80.

c) Pinned Top – Pinned Bottom



Both ends are restrained against lateral movement (translation) but, are allowed to rotate. "K" equals 1.0.

d) Fixed / Free Top – Fixed Bottom



The top is restrained against rotation but is allowed to move laterally. The bottom is restrained against rotation and lateral movement (translation). "K" equals 1.2.

CROSS-SECTIONAL SHAPE

The cross-sectional shape of a column member determines the value of its "Radius of Gyration" or "r". In general, a member with a large "r" makes a better column than a member with a small "r". Each axis of a column has a different "r". Typically the axis with the smallest "r" determines the final design.

BOLT TORQUE

Bolt torque values are given to ensure the proper connection between Unistrut Metal Framing components. It is important to understand that there is a direct, but not necessarily consistent, relationship between bolt torque and tension in the bolt. Too much tension in the bolt can cause it to break or crush the component parts. Too little tension in the bolt can prevent the connection from developing its full load capacity. The torque values given have been developed over many years of experience and testing.

Recommended Bolt Torque					
Bolt Size	1/4"	3/8"	1/2"	5/8"	3/4"
Foot Lbs.	6	19	50	100	125
N•m	8	25	70	135	170

These are based on using a properly calibrated torque wrench with a clean dry (non-lubricated) Unistrut fitting, bolt and nut. A lubricated bolt or nut can cause extremely high tension in the connection and may lead to bolt failure. It must be noted that the accuracy of commercial torque wrenches varies widely and it is the responsibility of the installer to ensure that proper bolt torque has been achieved.

AXIAL COLUMN LOADS

Loads based on AISI specifications for the design of Cold-Formed Steel Structural Members (1996 edition).

Loads are not given for $KL/R > 200$.

	Section Number	Axial Column Load (Lbs.)			
		K= 0.65	K=0.80	K=1.0	K=1.2
Column Unsupported Ht. – 24"	N1000	10,750	9,900	8,770	7,730
	N1001	25,060	24,620	23,900	23,050
	N3000	9,790	9,090	8,190	7,370
	N3001	22,670	22,250	21,580	20,780
	N3300	7,710	7,190	6,410	5,440
	N3301	17,400	16,820	15,900	14,840
	N5000	13,050	12,000	11,180	9,590
	N5001	30,190	29,820	29,220	28,500
	N5500	13,860	12,610	10,910	9,300
	N5501	32,840	32,310	31,440	30,410
Column Unsupported Ht. – 36"	N1000	8,910	7,730	6,370	5,280
	N1001	24,000	23,050	21,570	19,890
	N3000	8,300	7,370	6,320	5,440
	N3001	21,670	20,780	19,400	17,830
	N3300	6,520	5,440	4,030	2,830
	N3301	16,020	14,840	13,070	11,190
	N5000	11,380	9,590	7,390	5,560
	N5001	29,300	28,500	27,220	25,740
	N5500	11,120	9,300	7,190	5,550
	N5501	31,560	30,410	28,610	26,550
Column Unsupported Ht. – 48"	N1000	7,250	5,980	4,660	3,770
	N1001	22,590	21,030	18,690	16,170
	N3000	7,000	6,010	4,930	4,050
	N3001	20,350	18,890	16,710	14,390
	N3300	4,960	3,590	2,290	1,590
	N3301	14,270	12,450	9,930	7,540
	N5000	8,830	6,730	4,700	3,560
	N5001	28,100	26,750	24,660	22,320
	N5500	8,550	6,580	4,800	3,800
	N5501	29,850	27,950	25,070	21,960
Column Unsupported Ht. – 60"	N1000	5,890	4,660	3,600	2,940
	N1001	20,890	18,690	15,540	12,400
	N3000	5,930	4,930	3,860	3,120
	N3001	18,760	16,710	13,800	10,920
	N3300	3,480	2,290	1,470	KL/r>200
	N3301	12,290	9,930	6,970	4,840
	N5000	6,580	4,700	3,360	2,620
	N5001	26,630	24,660	23,090	19,770
	N5500	6,430	4,800	3,610	2,920
	N5501	27,780	25,070	21,160	17,200

	Section Number	Axial Column Load (Lbs.)			
		K= 0.65	K=0.80	K=1.0	K=1.2
Column Unsupported Ht. – 72"	N1000	4,800	3,770	2,940	2,380
	N1001	18,990	16,170	12,400	8,960
	N3000	5,060	4,050	3,120	2,290
	N3001	17,000	14,390	10,920	7,810
	N3300	2,410	1,590	-	-
	N3301	10,250	7,540	4,840	3,360
	N5000	4,890	3,560	2,620	2,090
	N5001	24,930	22,320	19,770	15,800
	N5500	4,970	3,800	2,920	2,390
	N5501	25,450	21,960	17,200	12,730
Column Unsupported Ht. – 84"	N1000	4,010	3,170	2,460	1,970
	N1001	16,970	13,640	9,470	6,580
	N3000	4,300	3,390	2,430	-
	N3001	15,120	12,050	8,270	5,740
	N3300	1,770	-	-	-
	N3301	8,260	5,550	3,550	-
	N5000	3,860	2,870	2,160	1,750
	N5001	23,070	21,110	16,450	12,100
	N5500	4,060	3,160	2,460	2,020
	N5501	22,950	18,770	13,460	9,350
Column Unsupported Ht. – 96"	N1000	3,450	2,730	2,090	1,650
	N1001	14,900	11,200	7,250	5,040
	N3000	3,690	2,880	1,860	-
	N3001	13,210	9,820	6,330	4,400
	N3300	-	-	-	-
	N3301	6,440	4,250	-	-
	N5000	3,180	2,410	1,850	1,510
	N5001	22,440	18,430	13,300	9,260
	N5500	3,450	2,720	2,130	1,740
	N5501	20,360	15,660	10,310	7,160
Column Unsupported Ht. – 120"	N1000	2,680	2,090	-	-
	N1001	10,910	7,250	4,640	-
	N3000	2,820	1,860	-	-
	N3001	9,560	6,330	4,050	-
	N3300	-	-	-	-
	N3301	4,120	-	-	-
	N5000	2,370	1,850	1,450	-
	N5001	18,100	13,300	8,540	-
	N5500	2,670	2,130	1,660	-
	N5501	15,280	10,310	6,600	-



BEAM CLAMPS

Material: †ASTM A575, A576 (Chemicals)/A1011SS [previously A570], Grade 33 (Physicals)
**ASTM A1011SS, Grade 33[previously A570]

N1271 NH †.....32	N1649 NH **.....33	N1652 NH †.....33	N2398 NH **.....33
N1272 NH †.....33	N1650 A NH **.....33	N1653 NH †.....33	N2401 NH **.....33
N1379 NH †.....33	N1650 NH **.....33	N1796 NH †.....32	N2403 NH *.....33
N1648 NH **.....33	N1651 A NH †.....33	N1985 NH †.....33	N2675 NH **.....32
N1649 A NH **.....33	N1651 NH †.....33	N1986 NH†.....33	N2676 NH **.....32

BRACKETS

Material: All HG, PL and GR Brackets Conform to ASTM A1011SS, Grade 33[previously A570] (NOTE 2)
All PG Brackets Conform to ASTM A653, Grade 33 (NOTE 2)

N2542.....28	N2545.....28	N2945.....28
N2543.....28	N2546.....28	N2946.....28
N2544.....28	N2944.....28	N2947.....28

CHANNEL

Material: All HG Channels Conform to: ASTM A1011SS, Grade 33[previously A570], All PG Channels Conform to” ASTM A653 Grade 33

N1000.....9	N1001 B3.....9	N3300.....11	N5001.....13
N1000 HS.....15	N1001 C.....9	N3300 HS.....15	N5500.....13
N1000 T.....15	N1001 C3.....9	N3300 T.....15	N5500 HS.....15
N1001.....9	N3000.....11	N3301.....11	N5500 T.....15
N1001 3.....9	N3000 HS.....15	N5000.....13	N5501.....13
N1001 A.....9	N3000 T.....15	N5000 HS.....15	
N1001 A3.....9	N3001.....11	N5000 T.....15	
N1001 B.....9			

CHANNEL NUTS & HARDWARE

Material: As shown for each part number

HSQN025EG	ASTM A563, Grade A/ANSI B1822.....19	NFLW025EG	ASTM F844/ANSI B18.22.1.....19
HSQN031EG	ASTM A563, Grade A/ANSI B1822.....19	NFLW037EG	ASTM F844/ANSI B18.22.1.....19
HSQN037EG	ASTM A563, Grade A/ANSI B1822.....19	NFLW050EG	ASTM F844/ANSI B18.22.1.....19
HSQN050EG	ASTM A563, Grade A/ANSI B1822.....19	NHCS050094EG	SAE J429, Grade 2/ANSI B18.2.1.....19
HSQN062EG	ASTM A563, Grade A/ANSI B1822.....19	NHCS050150EG	SAE J429, Grade 2/ANSI B18.2.1.....19
N1006-1420	ASTM A1011SS Grade 45.....18	NHXXN025EG	ASTM A563, Grade A/ANSI B18.2.2.....19
N1008	ASTM A576 Grade 1015 (Modified).....18	NHXXN037EG	ASTM A563, Grade A/ANSI B18.2.2.....19
N1010	ASTM A576 Grade 1015 (Modified).....18	NHXXN050EG	ASTM A563, Grade A/ANSI B18.2.2.....19
N1012	ASTM A675, Grade 60.....18	NLKW025EG	ASTM A29, Grade 1055-65/ANSI B18.21.1 (NOTE 3).....19
N1012 S	ASTM A675, Grade 60.....18	NLKW037EG	ASTM A29, Grade 1055-65/ANSI B18.21.1 (NOTE 3).....19
N1023	ASTM A675, Grade 60.....18	NLKW050EG	ASTM A29, Grade 1055-65/ANSI B18.21.1 (NOTE 3).....19
N1023 S	ASTM A675, Grade 60.....18	NSHS025075EG	SAE J429, Grade 2/ANSI B18.6.3.....19
N3006-1420	ASTM A1011SS Grade 45.....18	NSHS025100EG	SAE J429, Grade 2/ANSI B18.6.3.....19
N3008	ASTM A576, Grade1015 (Modified).....18	NSHS025125EG	SAE J429, Grade 2/ANSI B18.6.3.....19
N3010	ASTM A576, Grade1015 (Modified).....18	NSHS031100EG	SAE J429, Grade 2/ANSI B18.6.3.....19
N4006-1420	ASTM A1011SS Grade 45.....18	NSHS031125EG	SAE J429, Grade 2/ANSI B18.6.3.....19
N4008	ASTM A576, Grade1015 (Modified).....18	NSHS031137EG	SAE J429, Grade 2/ANSI B18.6.3.....19
N4010	ASTM A576, Grade1015 (Modified).....18	NSHS031175EG	SAE J429, Grade 2/ANSI B18.6.3.....19
N4012	ASTM A36.....18	NSHS037125EG	SAE J429, Grade 2/ANSI B18.6.3.....19
N4023	ASTM A36.....18	NTHR025	ASTM A193, Grade B7/ANSI B1.1.....19
N5506-1420	ASTM A1011SS Grade 45.....18	NTHR037	ASTM A193, Grade B7/ANSI B1.1.....19
N5508	ASTM A576, Grade 1015 (Modified).....18	NTHR050	ASTM A193, Grade B7/ANSI B1.1.....19
N5510	ASTM A576, Grade 1015 (Modified).....18		
NCSS037200EG	ASTM A29, Grade 1018-1022/ANSI B18.6.2.....19		
NCSS050150EG	ASTM A29, Grade 1018-1022/ANSI B18.6.2.....19		
NCSS050200EG	ASTM A29, Grade 1018-1022/ANSI B18.6.2.....19		

CONCRETE INSERTS

Material: **ASTM A1011SS, Grade 33[*previously A570*]

N1703 **35	N3280 **35	N3703 **35
N1704 **35	N3370 **34	N3704 **35
N2407 **35	N3380 **35	N4663 **35
N3270 **34	N3663 **35	P3712 P N/A34

GENERAL FITTINGS

Material: All General Fittings Conform to ASTM A575, A576(Chemicals)/A1011SS[*previously A570*], GRADE 33 (Physicals)

N102622	N135621	N196120	N232825
N102820	N135821	N2072 A27	N232925
N103120	N135922	N2072 ASQ27	N2343 R-L26
N103620	N137624	N2073 A27	N234526
N104523	N1376 A24	N207922	N234626
N104724	N137724	N209423	N234726
N104824	N138021	N209523	N246924
N104924	N1380 A21	N209623	N247120
N105024	N138222	N209723	N247325
N106220	N138325	N209823	N2815 D NH27
N106320	N145323	N209923	N2815 NH27
N106420	N145822	N210023	N286220
N106521	N154623	N210523	N286320
N106621	N172621	N210623	N286420
N106721	N173725	N210723	N304524
N106822	N175022	N210823	N304725
N118623	N183425	N210923	N334524
N120427	N1834 A25	N211023	N404524
N120527	N187321	N222326	N404725
N120627	N192421	N222426	N437625
N120727	N192521	N222526	N4376 A25
N120827	N194121	N222726	N437725
N128027	N195022	N222826	N554326
N132522	N195623	N222926	N554524
N132622	N195723	N223523	N554726
N134622	N195920	N232422		
N134723	N196020	N232625		

PIPE CLAMPS

Material: **ASTM A1011SS, Grade 33[*previously A570*]
 †ASTM A575, A576 (Chemicals)/A1011SS, Grade 33 (Physicals)

N1109 NH **29	N1123 NH **29	N1429 NH **30	N2026 NH **30
N1111 NH **29	N1124 NH **29, 30	N1430 NH **30	N2027 NH **30
N1112 NH **29	N1126 NH **29, 30	N1431 NH **30	N2028 NH **30
N1113 NH **29	N1211 NH **29	N2008 **31	N2029 NH **30
N1114 NH **29	N1212 NH **29	N2009 **31	N2030 NH **30
N1115 NH **29	N1213 NH **29	N2010 **31	N2031 NH **30
N1117 NH **29	N1214 NH **29	N2012 **31	N2032 NH **30
N1117 NH **30	N1215 NH **29	N2014 **31	N2033 NH **30
N1118 NH **29, 30	N1217 NH **29	N2016 **31	N2034 NH **30
N1119 NH **29	N1425 NH **30	N2018 **31	N2035 NH **30
N1120 NH **29	N1426 NH **30	N2020 **31	N2037 NH **30
N1121 NH **29	N1427 NH **30	N2024 NH **30	N2038 NH **30
N1121 NH **30	N1428 NH **30	N2025 NH **30	N2039 NH **30



PIPE CLAMPS

Material: **ASTM A1011SS, Grade 33[*previously A570*]
 †ASTM A575, A576 (Chemicals)/A1011SS[*previously A570*], Grade 33 (Physicals)

N2040 NH **30	N2070-61 NH **30	N2070-82 NH **30
N2042 NH **30	N2070-62 NH **30	N2070-83 NH **30
N2043 NH **30	N2070-63 NH **30	N2070-84 NH **30
N2044 NH **30	N2070-64 NH **30	N2558-05 **31
N2059 NH **30	N2070-66 NH **30	N2558-07 **31
N2060 NH **30	N2070-67 NH **30	N2558-10 **31
N2061 NH **30	N2070-70 NH **30	N2558-12 **31
N2062 NH **30	N2070-71 NH **30	N2558-15 **31
N2063 NH **30	N2070-72 NH **30	N2558-20 †.....31
N2064 NH **30	N2070-73 NH **30	N2558-25 †.....31
N2065 NH **30	N2070-74 NH **30	N2558-30 †.....31
N2066 NH **30	N2070-75 NH **30	N2558-35 †.....31
N2067 NH **30	N2070-76 NH **30	N2558-40 †.....31
N2068 NH **30	N2070-77 NH **30	N2558-50 †.....31
N2069 NH **30	N2070-80 NH **30	N2558-60 †.....31
N2070 NH **30	N2070-81 NH **30	

GENERAL NOTES:

Where not specified, both chemical analysis and physical properties (if applicable) apply to material specifications. Unless otherwise specified the material reference on parts with multiple components pertain to all components.

Note 1: These parts contain sub-components. The material specification for the end plate is ASTM A575, A576 (chemicals) A1011SS, Grade 33 (physicals).

Note 2: These parts contain sub-components. The material specification for the end plate is ASTM A36.

Note 3: The mechanical galvanizing specification for the lock washer is are ASTM B695, Class 5, Type 1.

Note 4: These parts contain sub-components. The material specifications of the sub-components are:
 Cap Screw SAE J429, Grade 2/ANSI B18.2.1;
 Hex Nut ASTM A563, Grade A/ANSI B18.2.2;
 Lock Washer ASTM A29, Grade 1055-65/ANSI B18.21.1

Note 5: ASTM A575, A576 (Chemicals) denotes that parts can be made from either material at the discretion of Unistrut.

Note 6: Unless otherwise specified, products made from ASTM A575/A576 will be grade 1010.

DISTRIBUTION SERVICE CENTERS

To serve you directly and dependably, there are over 50 Unistrut distribution service centers located throughout North America. For the nearest Unistrut Service Center, call 1-800-521-7730 or visit our website at www.unistrut.com.

UNISTRUT systems and products are manufactured under one or more of the following United States and Canadian patents and patent applications.

UNITED STATES PATENTS

3,721,463	3,888,441	3,948,012	4,277,923	4,575,295	4,822,199	4,926,592
3,861,107	3,914,063	3,968,624	4,278,228	4,593,514	4,830,531	5,046,291
3,877,275	3,927,499	3,994,111	4,289,415	4,616,799	4,840,525	DES297,668
3,888,440	3,928,930	4,073,114	4,562,681	4,784,552	4,895,331	

CANADIAN PATENTS

52,439	596,548	1,007,824	1,130,971	1,245,886	1,263,531	1,320,196
57,636	1,007,823	1,039,948	1,135,925	1,255,069	1,267,265	

TRADE NAMES

UNISTRUT systems and products are sold under many protected trade names including the following: BRITE-LINE, MR STRUT (& DESIGN) N1000, P1000, PERMA GREEN, ROOFWALKS, TELES PAR, TELESTRUT, UNI-CLIP, UNI-CUSHION, UNISTRUT (& DESIGN), UNITED INTERLOCK



Allied Tube & Conduit ▲ AFC Cable Systems ▲ Heritage Plastics ▲ Unistrut
Unistrut Construction ▲ Cope ▲ US Tray ▲ Calbrite ▲ Calbond ▲ Kaf-Tech
Columbia-MBF ▲ Eastern Wire + Conduit ▲ ACS/Uni-Fab ▲ Cii
Power-Strut ▲ Calconduit ▲ Razor Ribbon ▲ Calpipe Security
Vergokan ▲ Flexicon ▲ Marco

Atkore

16100 South Lathrop Avenue
Harvey, IL 60426

TOLL FREE / 800-882-5543

FAX / 708-339-7814

atkore.com/unistrut

Want to join a company that helps you build
the mindset, skill set and tool set for success?
Visit us at atkore.com/careers